

LLB Series

Compression Sensor Family Manual

Table of Contents

Key Features	3	Sensor DB-9 Assembly	9
Mechanical Installation	4	Shield Usage and Connections	10
Mounting and Installation	5	Calibration	10
Further Mounting Suggestions	6	Troubleshooting	11
Cable Care and Routing	7	Further Support Resources	13
Electrical Installation	8		



Key Features

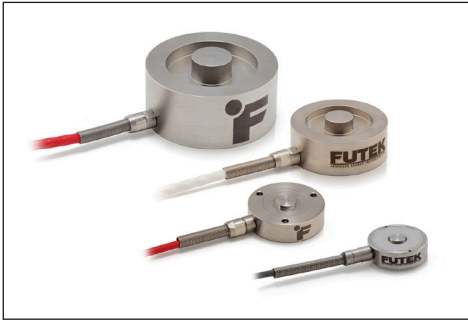

We offer a wide selection of button load cells.

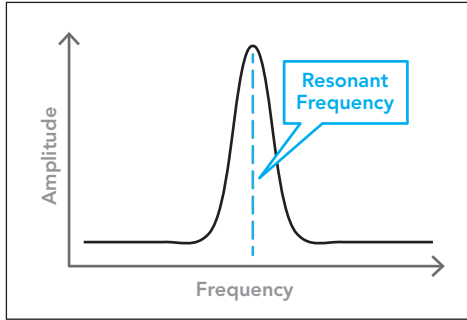

Robust stiff design results in ultra-low deflection and fast (or high) natural frequencies.

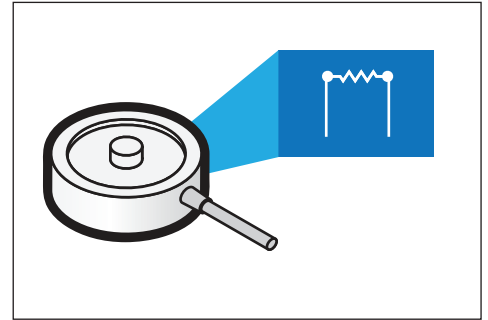

Our entire LLB line is fully internally temperature compensated, which means there is no external conditioning circuitry.

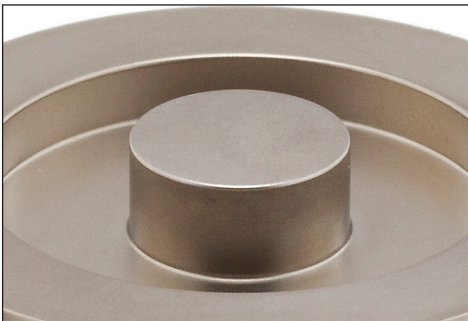

The slightly spherical load button design helps center loads, improving accuracy.



Fully welded design (on select models).

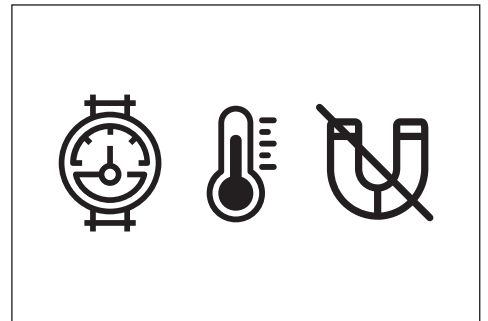

High IP ratings on select models: Submersible, Vacuum compatible, non-magnetic, and high temperature compensated versions available.

Mechanical Installation

The following items should be observed to avoid damage to the LLB sensor during installation and usage.

- Avoid conditions that exceed the sensors IP rating.
- Store in a dry area without fixtures.

MAXIMUM MOMENTS AND OFF-AXIS LOADING

- Extraneous load information can be used to assist in determining if the sensor can withstand any unavoidable off-axis loads and moments. Extraneous load information can be found at: <http://www.futek.com/extraneous-load-factor>
- An extraneous how-to guide can be found at: https://media.futek.com/content/futek/files/pdf/Extraneous_Load_Factors/How_To_Calculate_Extraneous_Loads.pdf

MAXIMUM INSTALLATION TORQUE

- LLB210 and LLB215 Threaded Load Buttons have a maximum installation torque of 5 in-lb.

1. Do not pull on or carry sensor by cable.

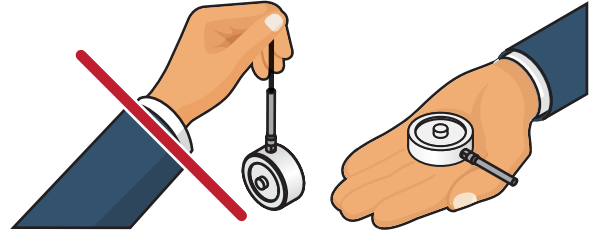

2. Monitor sensor output for effects on zero output during installation to avoid damage.



3. Install in a dry, clean environment.

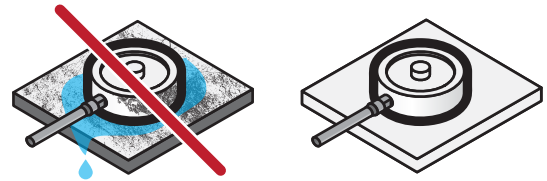

4. Fixture must not contact non-loading surface





Mounting and Installation

Below is information for proper mounting and installation. Refer to the sensor spec sheet for thread information and proper load cell orientation to maximize performance and limit cable interference.

- Measurements are called out on the sensor spec sheet and have the following tolerances based on the number of decimal points present.

DECIMAL FORMAT	TOLERANCE
0.x	±0.1"
0.xx	±0.01"
0.xxx	±0.005"
0.xxxx	±0.001"

-  Non-loading surface, do not contact
-  Active End
-  Fixed End

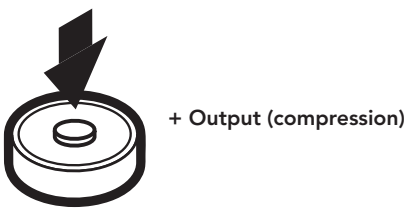
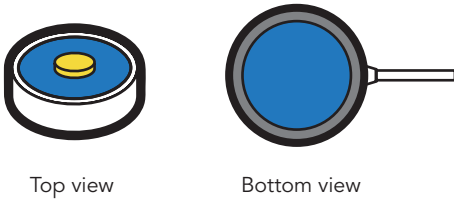

1. Load must be in line and centered

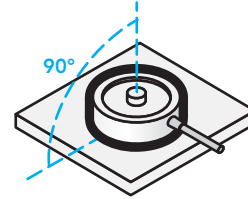

2. Support surfaces must be flat and inline

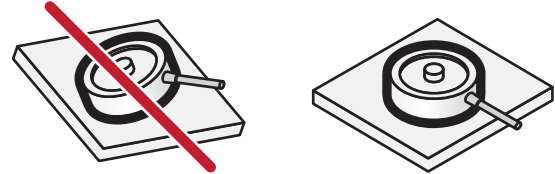

3. Support on the outer ring only

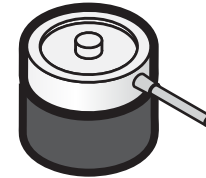

4. Sensor cannot be used in tension

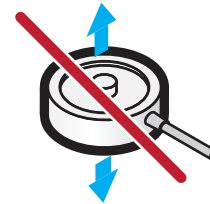

Further Mounting Suggestions

-
1. Secure from outer lip

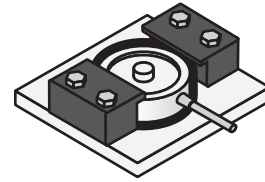

-
2. Mount using thread holes

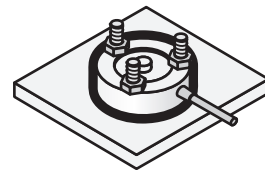

-
3. Retain with set screw, hand tighten to prevent overloading the sensor

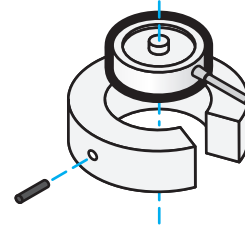

-
4. Mount in counterbore hole. It is recommended to allow for +0.005" to the upper tolerance for outer diameter for any sensor expansion while under load.

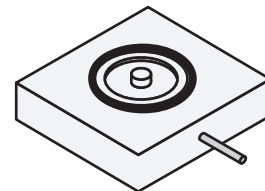

Cable Care and Routing

- Below is information for proper cable care and handling. Cable material type and length can be found online in the sensor description page.

1. Avoid adding stress and moving both the cable and strain relief to avoid damage.

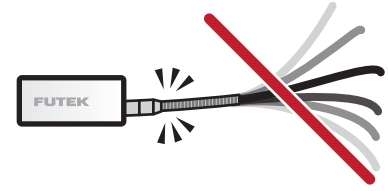

2. Properly secure sensor cable to limit cable movement influence.

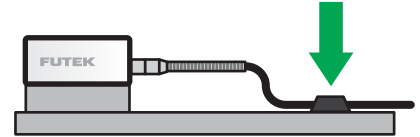

3. Avoid bending the strain relief. Bends in the cable should not exceed a radius of ten times the diameter of the sensor cable for dynamic, or moving, applications and not exceed a onetime static, permanent, bend of two to three times the diameter of the cable.

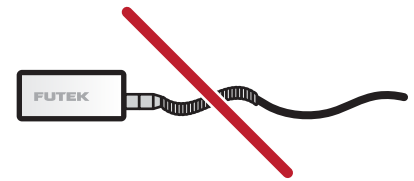

CABLE JACKET REFERENCE

MATERIAL	TEMP	CHEMICAL EXPOSURE	TARGET APPLICATION	HANDLING	NOTES
Teflon	Excellent	Excellent	Industrial, medical, aerospace	Robust, slick	
PVC (polyvinyl chloride)	Good	Good	General	Soft, flexible, easy to use	Not suitable for cold applications
Silicone	Average	Fair	Automation	Soft, flexible, easy to use	
Polypropylene	Good	Good	Automation	Soft, flexible, easy to use	
Polyester	Good	Good	General	Soft, flexible, easy to use	
Polyurethane	Average	Good	Automation	Soft, flexible, easy to use	Not suitable for thermal chambers

Electrical Installation

WIRING AND CONNECTIONS

- The LLB load cell series utilizes a four-wire bare lead connection.
- Standard four wire connections are +Excitation, -Excitation, +Signal, and -Signal. The standard coloring code for the above listed connections are Red, Black, Green, and White.
- Six wire connections offer additional +Sense and -Sense connections or TEDS data and TEDS return connections. Additional connection standard colors are Orange and Blue.

LLB EXCITATION POWER LEVELS

SENSOR FAMILY	MAX. EXCITATION
LLB130	7 V
LLB210	7 V
LLB250	7 V
LLB300	18 V
LLB350	18 V
LLB390	15 V
LLB400	18 V
LLB450	18 V
LLB500	18 V

WC1s STANDARD 4-WIRE WITH SHIELD

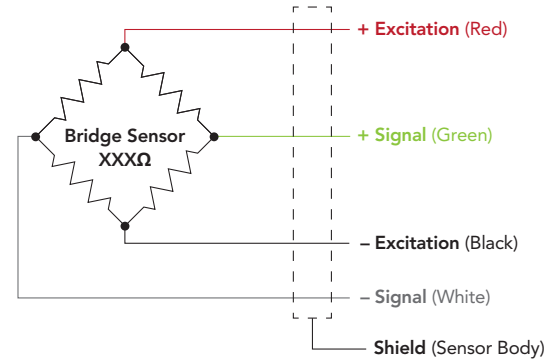

WC1 STANDARD 4-WIRE

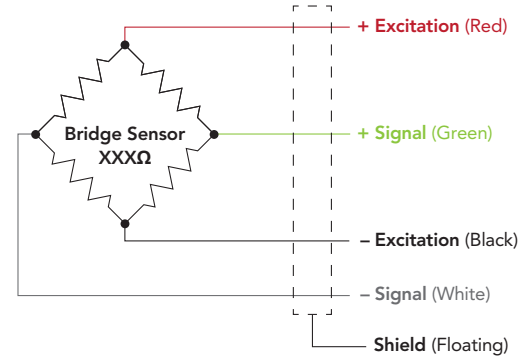

CC15 DB-9 W/ TEDS

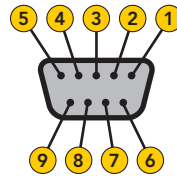

DB9 W/ TEDS

PIN	DESCRIPTION
1	+ Signal
2	+ Excitation
4	+ Sense ¹
5	TEDS Data
6	- Signal
7	- Excitation
8	- Sense ¹
9	TEDS Ground

¹For 6-wire sensors, connect + Sense to + Excitation and - Sense to - Excitation or Ground

Sensor DB-9 Assembly

MALE DB9 CONNECTOR (SUPPLIED)

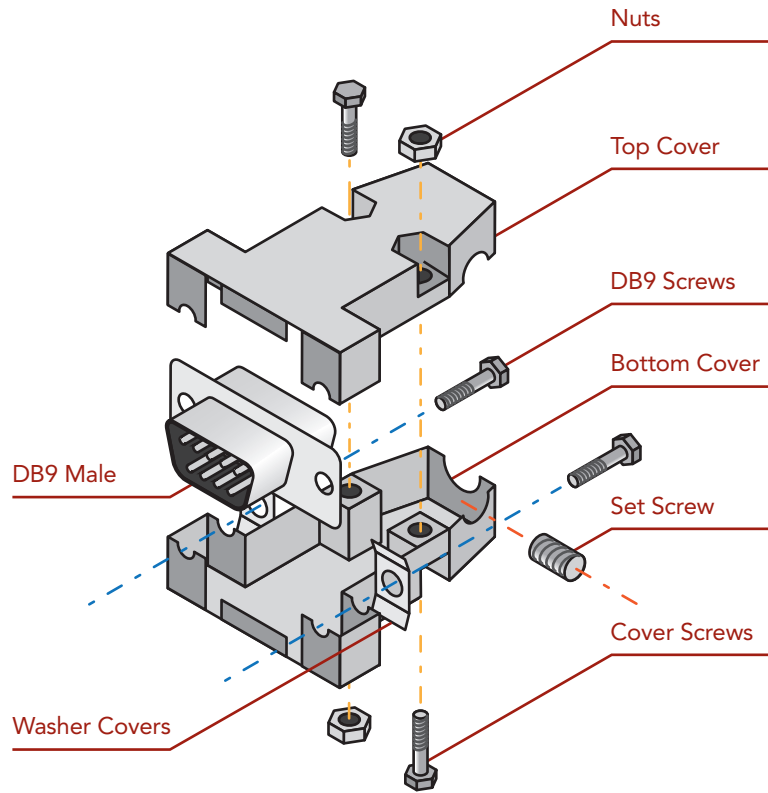

Shield Usage and Connections

- Cable shielding should be grounded on one end, either the sensor side or instrument side to avoid ground loops.
- A shield connection listed as floating on a sensors spec sheet means the cable shield is not connected on the sensor side and may be connected on the instrument side to ground.

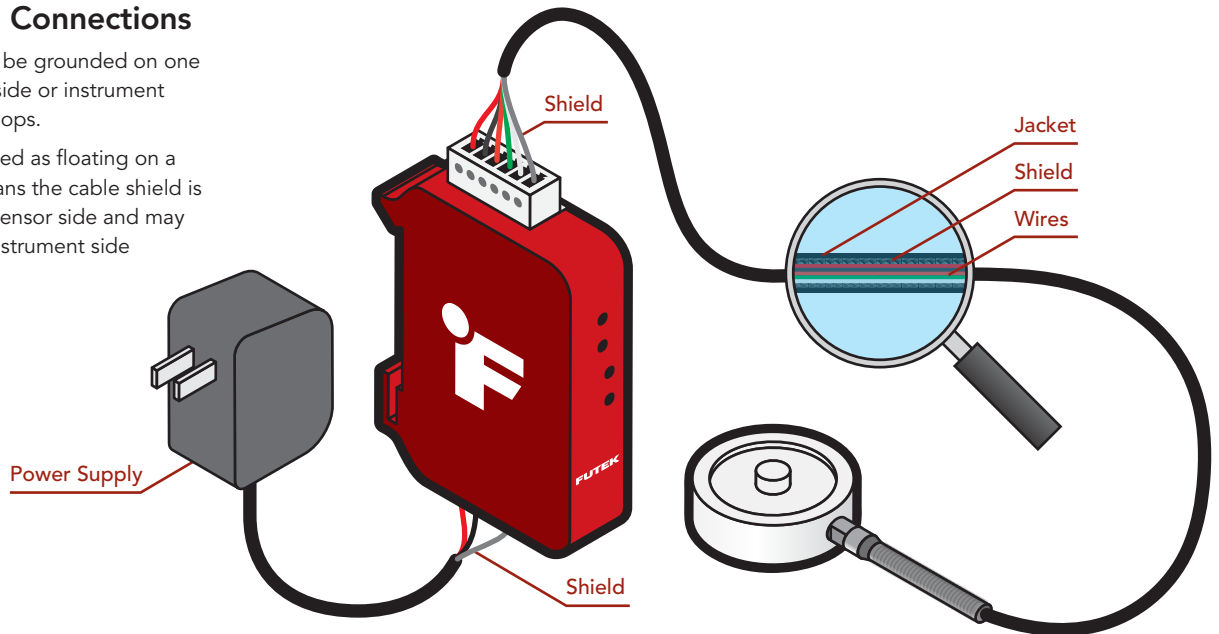

Calibration

- A yearly calibration is recommended. But verification and calibration period shall be defined based on application, conditions, endurance and usage.
- FUTEK offers NIST calibrations as well as A2LA certified calibrations for total uncertainty.
- For more information on available calibrations visit FUTEK calibration web page at: <https://www.futek.com/store-calibration>
- For recalibration orders visit the FUTEK recalibration page at: <https://www.futek.com/recalibration>
- An online summary of calibration results is available at: <https://www.futek.com/support/calibrationdata>

SHUNT

A shunt is an external resistance applied across two points on the load cell's Wheatstone bridge to generate a known, fixed output from the sensor.

Shunt results can be used to set up instruments as well as compare changes to the load cell output over time and usage.

When selecting the appropriate shunt resistance for your load cell, we recommend a resistance that generates an output of about 80% of the sensor's rated output. It is important to have a shunt resistance that results in an output that is less than the full output of the load cell.

Additionally, recommended shunt resistance levels may be available on the sensor spec sheet.

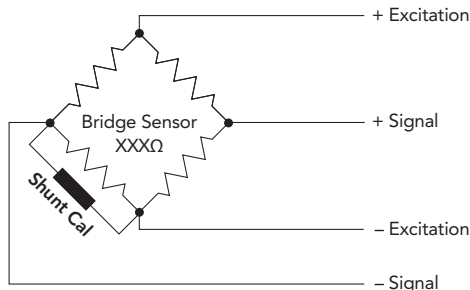

TEDS

Transducer Electronic Data Sheet (TEDS) IEEE1451.4 standard is available for FUTEK sensors and is utilized by select FUTEK instruments.

Through the use of TEDS load cell calibration information can be stored with sensor, or sensor cable, for use with TEDS capable instruments.

FUTEK utilizes the Bridge Sensor template 33 for the LLB family.

The following FUTEK instruments are TEDS and LLB compatible:



IPM Series
Panel Mount Displays



IHH Series
Handheld Instruments

Troubleshooting

When troubleshooting, we recommend that the sensor be removed from any fixtures. In order to confirm that that sensor is operating correctly, we suggest placing the sensor on a firm surface, and to apply a known load.

We also recommend using a volt meter with a clean to stable power supply to confirm the sensor is operating correctly.

SYMPTOM	POSSIBLE CAUSE	CHECK	REPAIRABILITY
High zero output	<ul style="list-style-type: none"> • Sensor is under preload • Sensor has been overloaded from too much load, off axis load, or moment. • Sensor has experienced high cyclical load fatigue. 	<ul style="list-style-type: none"> • Fixtures or bolting stress for causes of pre-load. • Loading and support placement for off axis loads. • Avoid excessive moments during installation. 	<ul style="list-style-type: none"> • Overload shift would not be repairable. • If zero offset is stable it may be possible to use sensor by use of Tare or subtracting zero from sequential readings.
Non-responsive zero output Excessive voltage can damage strain gages also.	<ul style="list-style-type: none"> • Sensor or instrument is not powered. • Sensor is not properly connected. • Load is not displaced properly onto sensor. • Sensor is not supported correctly and not allowing deflection to occur to measure load. • Internal disconnect or short. 	<ul style="list-style-type: none"> • Power and wiring to sensor and instrument. • Sensor bridge resistance for possible opens or shorts. • Perform continuity test test on sensor mating cable. • Load is placed correctly on sensor loading surface. • Sensor loading surface is not obstructed or supported and able to flex under load. • Sensor support is not giving while sensor is loaded. 	<ul style="list-style-type: none"> • Internal disconnections or shorts would not be available for repair. • Sensor cable repair may be available if disconnect or short is not too close to sensor.
Non-responsive high output	<ul style="list-style-type: none"> • Sensor is disconnected from instrument. • An opening has occurred in sensor or cable connection. • Sensor has been overloaded and deformed causing permanent high stress on internal gauges. • Fixture, applied load, or mounting is causing a high pre-load on sensor. 	<ul style="list-style-type: none"> • Power and wiring to sensor and instrument. • Sensor bridge resistance for possible opens or shorts. • Perform continuity check on cable. • Sensor zero output to see if sensor returns to zero or has a high zero load output due to overloading. • Remove load and loosen mounting bolts or fixtures to check if sensor is being preloaded. 	<ul style="list-style-type: none"> • Overload shift would not be repairable. • Internal disconnections or shorts would not be available for repair. • Sensor cable repair may be available if disconnect or short is not too close to sensor.
Incorrect output for applied load	<ul style="list-style-type: none"> • Load is not applied correctly to sensor loading surface or is off axis. • Fixtures are not secure or obstruct loading. • Sensor loading surface is not able to deflect with applied load. • Sensor support is not ridged and firm. • Incorrect sensor output is utilized. 	<ul style="list-style-type: none"> • Placement of load on sensor. • Fixtures are not impeding ability to load. • Support surface is not giving with applied load. • Calibration verified outputs are being used. 	<ul style="list-style-type: none"> • Recalibration is available for confirmation of sensor performance.

SYMPTOM	POSSIBLE CAUSE	CHECK	REPAIRABILITY
Zero output drift	<ul style="list-style-type: none"> • Unstable power supply, or noisy power supply, to sensor. • Sensor exposed to temperature change. • Sensor exposed to pre-load from fixture or mounting. • Sensor exposed to liquid or humidity. 	<ul style="list-style-type: none"> • Stability of power supply and noise levels. • For temperature changes or unevenly distributed temperature changes. • Possible loose fixtures and bolts 	<ul style="list-style-type: none"> • Internal damage from liquid exposure is not repairable. • Recalibration is available for confirmation of sensor performance.
Creep in output while under load	<ul style="list-style-type: none"> • Load or fixtures are not stable. • Power supply is unstable or noisy. • Sensor is exposed to temperature change. • Sensor support is not rigid and firm. • Sensor exposed to liquid or humidity. • Friction in assembly 	<ul style="list-style-type: none"> • Stability of power supply and noise levels. • Fixtures for stability. • For temperature changes or unevenly distributed temperature changes. • Confirm support surfaces are not giving while under load. 	<ul style="list-style-type: none"> • Internal damage from liquid exposure is not repairable. • Recalibration is available for confirmation of sensor performance.
Noisy or unstable output	<ul style="list-style-type: none"> • Power supply is noisy. • Load is not stable. • Sensor or cable is placed close to high power equipment. • Sensor or instrument is exposed to ground loop with other equipment grounds. 	<ul style="list-style-type: none"> • Power supply stability. • Load is stable and fixtures are secure. • Reroute cables away from high power equipment. • Confirm wiring and grounds are not connected to unintended equipment ground. 	<ul style="list-style-type: none"> • There are no active electronics in a load cell, such as capacitors or IC chips that may contribute to noise.

Further Support Resources

- Tips on noise reduction can be found at: https://media.futek.com/content/futek/files/pdf/Manuals_and_Technical_Documents/how-to-reduce-electrical-noise-in-your-system.PDF
- More information about our LLB sensor series can be found online at the FUTEK website. https://media.futek.com/content/futek/files/pdf/Manuals_and_Technical_Documents/LLBSeriesManual.pdf
- A one year recalibration is recommended. But verification and calibration period shall be defined based on application, conditions, endurance and usage. Calibration data may be available online at <https://www.futek.com/support/calibrationdata>
- To send in your sensor or system for recalibration visit our FUTEK calibration web page at: <https://www.futek.com/recalibration>
- FUTEK Technical Support may be reached at: <https://www.futek.com/contact/technical-request>
- To send in your sensor or system for evaluation and repair visit our FUTEK RMA web page at: <https://www.futek.com/rma>
- FUTEK contact information can be found online at: <http://www.futek.com/contact>
- Warranty information can be found online at <https://media.futek.com/content/futek/files/pdf/ExtendedWarranty.pdf>

Drawing Number: EM1038-A

10 Thomas, Irvine, CA 92618 USA

Tel: (949) 465-0900

Fax: (949) 465-0905

www.futek.com



U.S. Manufacturer