

- Low Noise: 10 $\mu\text{g}/\sqrt{\text{Hz}}$ Typical for $\pm 2\text{g}$ Full Scale Versions
- -55 to +125°C Operating Temperature Range
- Acceleration and Vibration Sensing Across Three Orthogonal Axes
- Excellent Long-Term Stability
- Flexible +8 to +32 VDC Power
- $\pm 4\text{V}$ Differential Output or 0.5V to 4.5V Single Ended Output
- Responds to frequencies from zero (DC) to 2000+ Hz
- Low Impedance Outputs Support up to 2000 Feet of Cable
- Eight (8) Wire Connection, Choice of Integrated Cable or Connector
- Rugged Anodized Aluminum Case
- Fully Calibrated and Serialized for Traceability

AVAILABLE G-RANGES

FULL SCALE ACCELERATION	MODEL SUFFIX
$\pm 2\text{ g}$	-002
$\pm 5\text{ g}$	-005
$\pm 10\text{ g}$	-010
$\pm 25\text{ g}$	-025
$\pm 50\text{ g}$	-050
$\pm 100\text{ g}$	-100
$\pm 200\text{ g}$	-200
$\pm 400\text{ g}$	-400

PREMIUM HIGH-PERFORMANCE ACCELEROMETER MODELS 2470 AND 2476



SDI's Premium Models 2470 and 2476 High-Performance Three-Axis MEMS Variable Capacitive Accelerometers are rugged plug-and-play measurement devices suitable for a wide array of demanding applications. Both models provide enhanced performance over temperature for use in zero to medium frequency applications experiencing large or rapid temperature variations or maintaining hot or cold extremes for extended periods of time.



The 2470 comes in a traditional 1-inch square package with an integrated cable and is operationally identical to the 2476, which features a connector instead of integrated cable for quick installations and removal without altering the cabling. The 2470 and 2476 incorporate three orthogonally mounted, hermetically sealed, low noise SDI Model 1522 surface mount accelerometers, which are individually tested, programmed, calibrated and verified in a climate chamber to ensure the greatest accuracy in thermally volatile conditions. The 2470 and 2476 include initial calibration reports detailing the test performance data.

Onboard voltage regulation and an internal voltage reference eliminate the need for precision power supplies. The robust, anodized aluminum case is potted then epoxy sealed and can be mounted easily via two screws, an adhesive, or by attaching a magnet. Individual axis directions are marked on the case with positive acceleration defined as acceleration in the direction of the axis arrow.

ZERO (DC) TO MEDIUM FREQUENCY APPLICATIONS



PERFORMANCE BY G RANGE

INPUT RANGE	SENSITIVITY, DIFFERENTIAL	*FREQUENCY RESPONSE (TYPICAL, 5%)	*FREQUENCY RESPONSE (TYPICAL, 3 DB)	*FREQUENCY RESPONSE (MINIMUM, 3 DB)	OUTPUT NOISE, DIFFERENTIAL (RMS, TYPICAL)	MAX. MECHANICAL SHOCK (0.1 MS)
g	mV/g	Hz	Hz	Hz	$\mu\text{g}/(\text{root Hz})$	g (peak)
± 2	2000	0 - 250	0 - 525	0 - 300	10	2000
± 5	800	0 - 400	0 - 800	0 - 420	15	
± 10	400	0 - 700	0 - 1100	0 - 660	23	
± 25	160	0 - 1300	0 - 1750	0 - 1050	38	
± 50	80	0 - 1600	0 - 2100	0 - 1400	60	
± 100	40	0 - 1700	0 - 3000	0 - 1700	121	5000
± 200	20	0 - 1900	0 - 3600	0 - 2100	243	
± 400	10	0 - 2000	0 - 4200	0 - 2400	475	

By Model: $V_{DD}=V_R=5.0\text{ VDC}$, $T_C=25^\circ\text{C}$

Single ended sensitivity is half of values shown.

SPECIFICATIONS SUBJECT TO CHANGE WITHOUT NOTICE

PERFORMANCE - ALL VERSIONS

All Models: Unless otherwise specified, $V_s = +8$ to $+32$ VDC, $T_C = 25^\circ\text{C}$, Differential Mode. Span = $\pm g$ range = 8000 mV.

PARAMETER	MIN	TYP	MAX	UNITS
Bias Calibration Error (%)		0.25	0.6	\pm % of span
Bias Calibration Error (mV)		25	60	\pm mV
Scale Factor Calibration Error ¹		0.5	1.25	\pm %
Non-Linearity (-90 to +90% of span) ¹		0.15	0.5	\pm % of span
Bias Temperature Shift (Coefficient)	-100	0	+100	(PPM of span)/ $^\circ\text{C}$
Scale Factor Temperature Shift (Coefficient)	-150	0	+50	PPM/ $^\circ\text{C}$
Cross Axis Sensitivity		2	3	\pm %
Power Supply Rejection Ratio	50	>65		dB
Output Impedance		1		Ω
Output Common Mode Voltage		2.5		VDC
Operating Voltage	8		32	VDC
Operating Current (AOP & AON open)	19	23	27	mA DC
Operating Temperature	-55		+125	$^\circ\text{C}$
Mass (not including cable)		21		grams
Cable Mass (3' integrated cable)		25		grams/meter

Note 1: For 2g thru 50g only; 100g and greater versions are tested and specified from -65 to +65g.

NOTICE: Stresses greater than those listed may cause permanent damage to the device. These are maximum stress ratings only. Functional operation of the device at or above these conditions is not implied.

BIAS & SCALE FACTOR TEMPERATURE SHIFT EXPLAINED

Every accelerometer has a bias and scale factor temperature coefficient, meaning the output shifts slightly due to temperature changes. Many applications operate within a relatively small temperature band or at room temperature, and therefore rarely encounter interference from the bias or scale factor temperature shifts. These customers are ideal candidates for SDI's Model 2460 or 2466 triaxial accelerometer modules.

For applications experiencing larger temperature variations (i.e. exposure to engine temperatures or arctic testing) SDI suggests the upgraded High-Performance 2470, 2476, and 2480 accelerometer modules. These have enhanced, temperature compensated, proprietary SDI Model 1522 accelerometer chips, which are individually tested, calibrated and verified in a climate chamber to provide the most accuracy and come with an initial calibration certificate.

Bias	The accelerometer output with no acceleration present. For SDI's differential output analog accelerometers, it is a signed quantity that is expressed in terms of either g or output volts and is ideally equal to zero g or zero volts.
Scale Factor	The ratio of the change in output to a unit change in the input acceleration expressed in millivolts per g (mV/g). Since the output of most accelerometers is slightly non-linear, the scale factor value is defined as the slope of the least-squares-fit line to the acceleration input vs output curve. SDI measures over the range of -90% to +90% of full scale or from -65g to +65g, whichever is smaller.
Bias Temperature Shift (Coefficient)	The amount of bias shift to expect with a change in temperature expressed as PPM of span per $^\circ\text{C}$. For example, the percent of span bias shift that would occur for a 25g full scale device with a +/-200 PPM of span per $^\circ\text{C}$ rating and a 55 $^\circ\text{C}$ rise from room temperature would be: $\pm 200 / 1,000,000 \times (80\text{C} - 25\text{C}) \times 100\%$ of span = $\pm 1.1\%$ of span. The g shift would be $\pm 1.1\%$ of 50g = 0.55 g. This error in terms of output voltage for a 25 g analog accelerometer would be $\pm 1.1\%$ of span = $\pm 1.1\%$ of 8 V = 88 mV.
Scale Factor Temperature Shift (Coefficient)	The amount of scale factor shift to expect with a change in temperature expressed as PPM per $^\circ\text{C}$. For example, the percent shift in scale factor that would occur for a device with a +200 PPM per $^\circ\text{C}$ rating and a 60 $^\circ\text{C}$ rise from room temperature would be: $200 / 1,000,000 \times (85\text{C} - 25\text{C}) \times 100\%$ = +1.2%. For an analog 10g device, the scale factor would rise from its nominal $(8 \text{ V}) / (20 \text{ g}) = 400 \text{ mV/g}$ at +25C to $400 \text{ mV/g} + 1.2\% = 404.8 \text{ mV/g}$.

SPECIFICATIONS SUBJECT TO CHANGE WITHOUT NOTICE

OPERATION

SDI's Universal Triaxial MEMS Variable Capacitive Accelerometers provide optimal performance when they are connected to instrumentation in a differential configuration using both the AOP and AON output signals, but still support single ended operation for complete flexibility.

These Accelerometers produce three differential analog output voltage pairs (AON & AOP) which vary with acceleration. The signal outputs are fully differential about a common mode voltage of approximately 2.5 volts. At zero acceleration, the output differential voltage is nominally 0 volts DC; at \pm full scale acceleration, the output is ± 4 volts DC, respectively, as shown in the figure (below). The output scale factor is independent from the supply voltage of +8 to +32 volts.

When a differential connection is not possible, SDI recommends connecting the accelerometer to instrumentation in single ended mode by connecting AOP and GND to the instrumentation and leaving AON disconnected. Keep in mind that the signal to noise ratio is reduced by half for a single-ended vs. a differential connection.

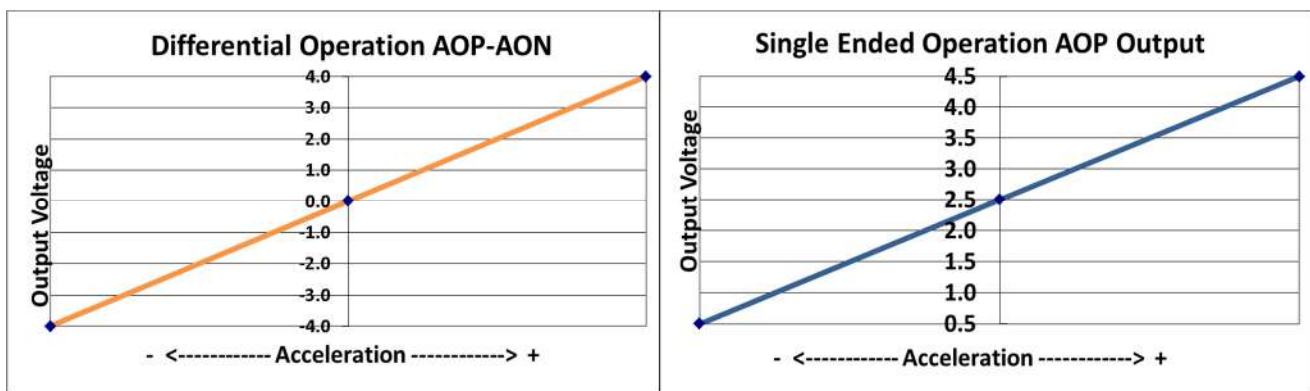

CABLE SPECIFICATIONS

2470: The SDI 2470 has an integrated 3' cable with strain relief attached at the connection to the case and consists of seven 28 AWG (7x36) and one 26 AWG (7x34) tin-plated copper wires. The seven smaller 28 AWG wires are covered by 5.5 mils of Teflon FEP insulation. The large single 26 AWG wire is covered by 8.5 mils of black Teflon FEP insulation. The seven smaller gauge wires surround the single larger gauge (black) wire. The cable's braided shield is electrically connected to the case. The black ground (GND) wire is isolated from the case. The wire bundle is surrounded by a braided shield and covered by a 10 mil thick Teflon FEP jacket with a nominal outer diameter of 0.136".

2476: The SDI 2476 has a 9-pin connector; the cable consists of eight 26 AWG tin-plated copper wires and only eight pins are used for the 8-wire cable. All eight of the 26 AWG wires are covered by 8.5 mils of Teflon insulation.

Both cable styles end in an 8-wire pigtail.

SPECIFICATIONS SUBJECT TO CHANGE WITHOUT NOTICE

RECOMMENDED CONNECTIONS - DIFFERENTIAL

SDI Models 2470 and 2476 Accelerometers provide optimal performance when they are connected to instrumentation in a differential configuration using both the AOP and AON output signals.

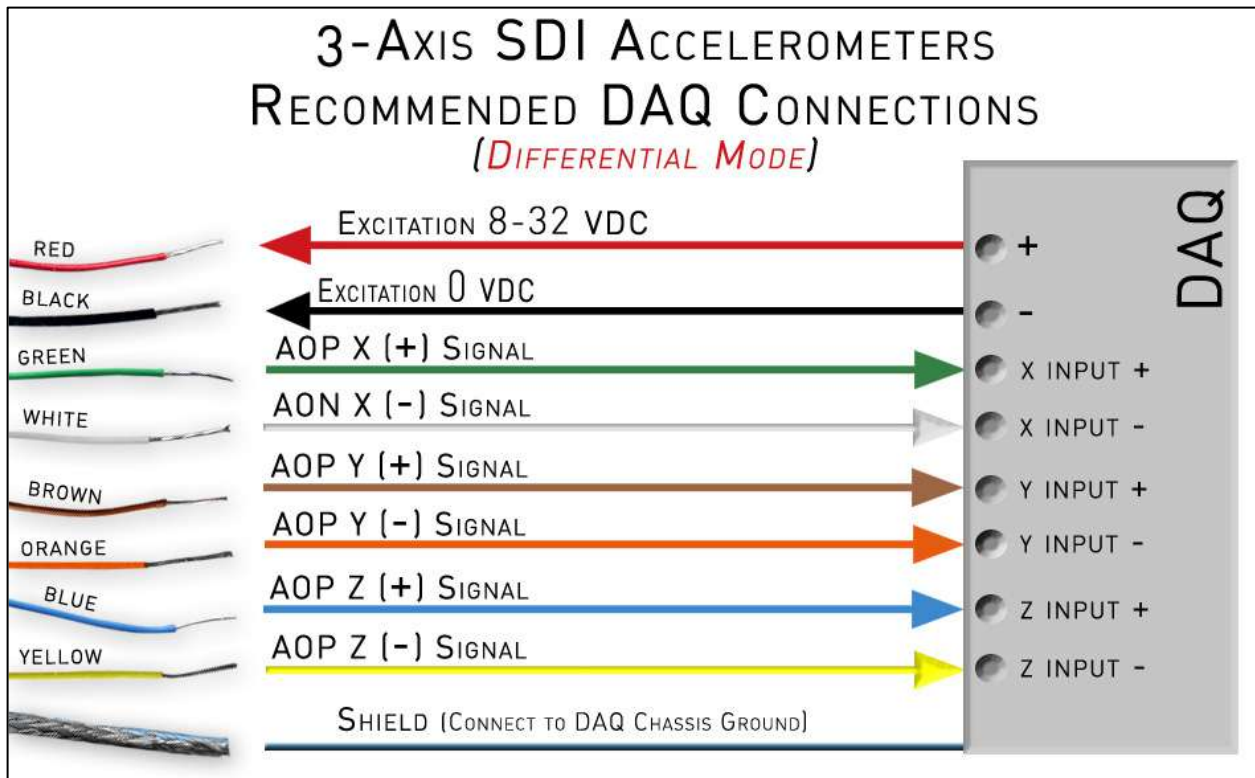
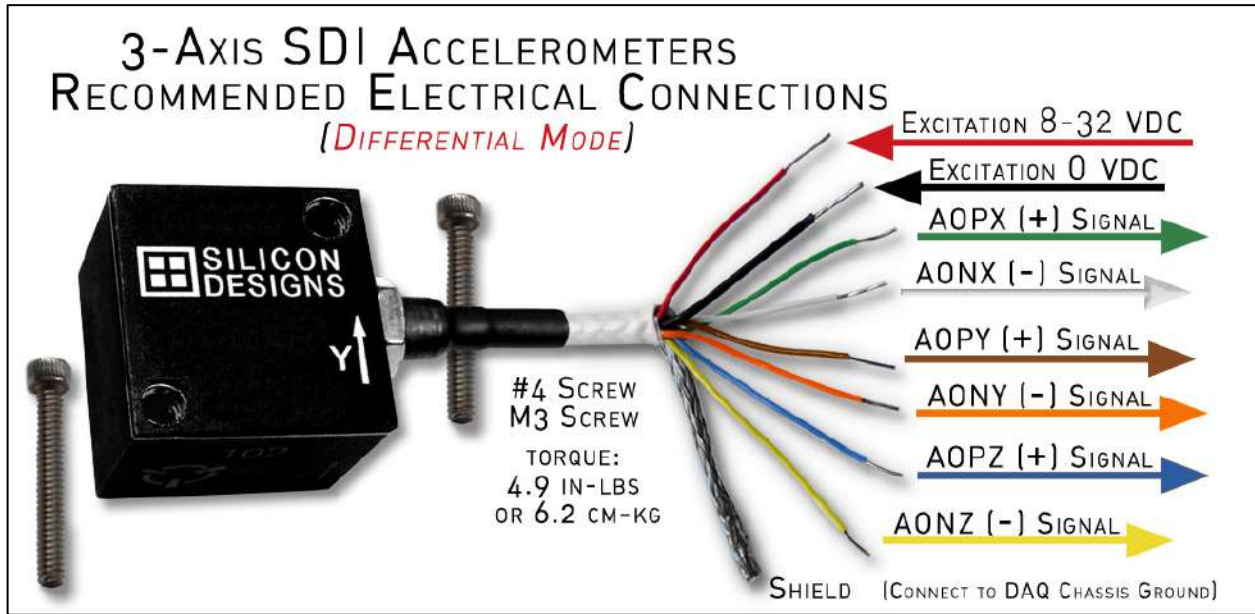

SPECIFICATIONS SUBJECT TO CHANGE WITHOUT NOTICE

RECOMMENDED CONNECTIONS – SINGLE ENDED

Single ended operation is also possible with minor changes to the wiring configuration, as described below.

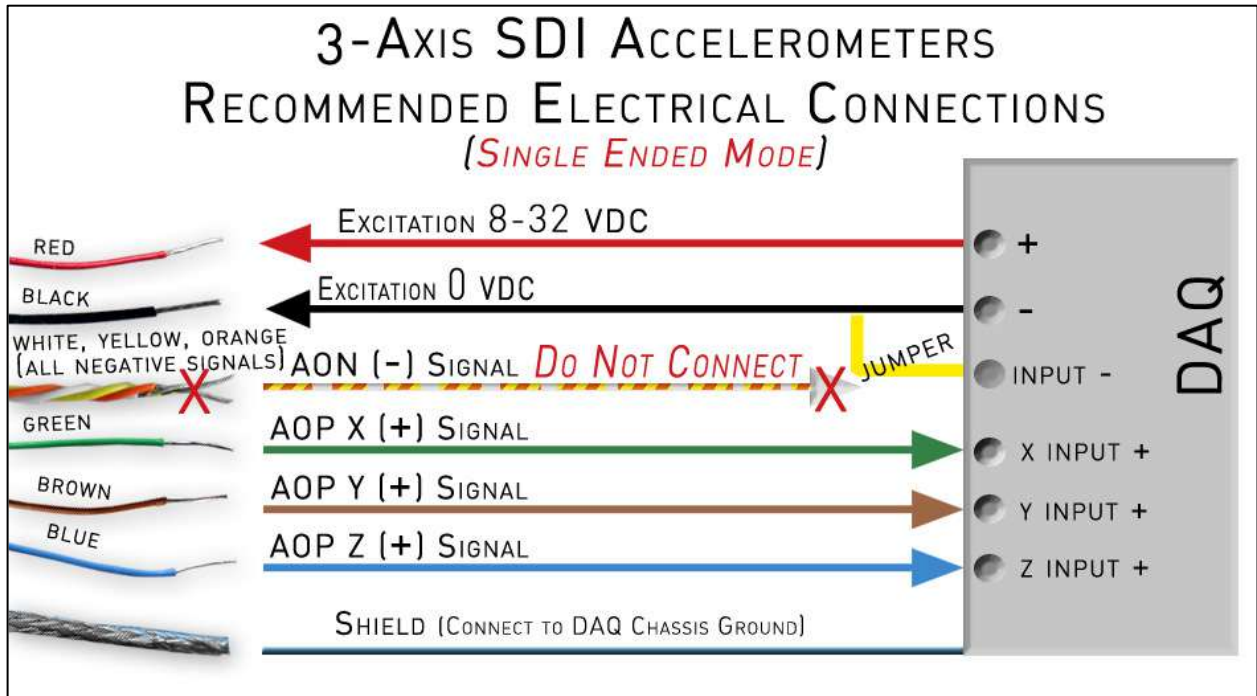
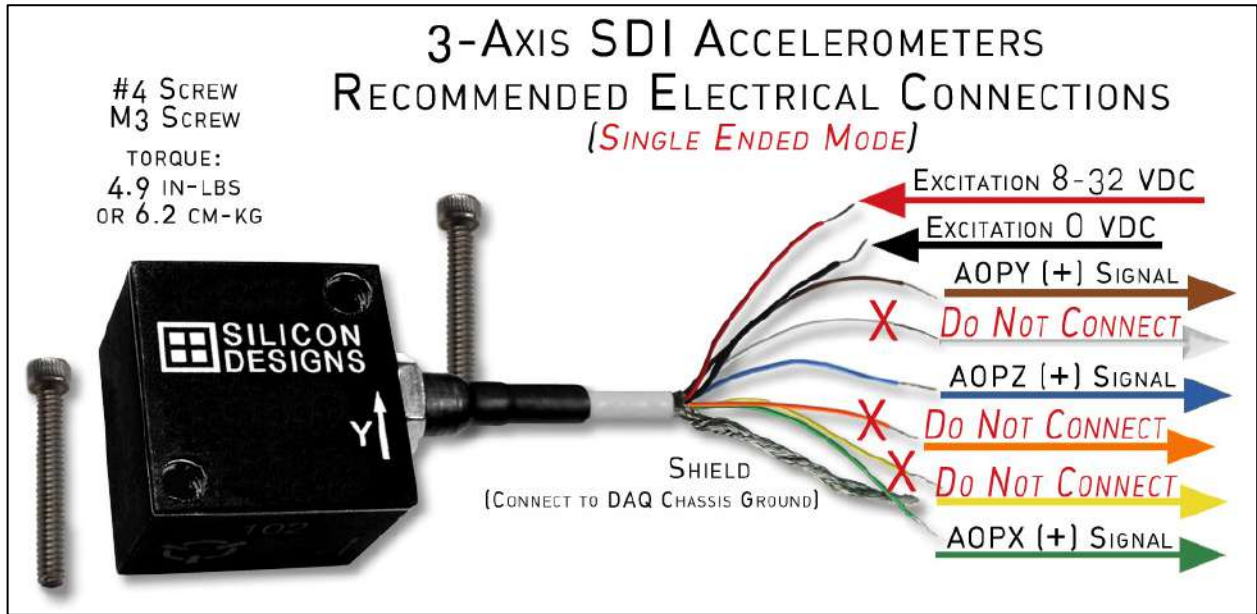

SPECIFICATIONS SUBJECT TO CHANGE WITHOUT NOTICE

2476 CABLE LENGTHS



The 8PIN-CAB is available in five standard lengths, and custom lengths may be available for special order.

NAME	LENGTH - FEET	LENGTH - METERS (APPROXIMATE)
8PIN-CAB-04	4 Feet	1.2 Meters
8PIN-CAB-10	10 Feet	3 Meters
8PIN-CAB-20	20 Feet	6 Meters
8PIN-CAB-33	33 Feet	10 Meters
8PIN-CAB-50	50 Feet	15.4 Meters

CABLE LENGTH CONSIDERATIONS

Cable lengths of up to 50 feet (15 meters) can be used without the need to test for output instability. For cable lengths exceeding 50 feet, Silicon Designs recommends checking each individual installation for oscillation by tapping the accelerometer and watching the differential output for oscillation in the 20 kHz to 50 kHz region. If no oscillation is present, extended cable length should behave as expected. From the standpoint of output current drive and slew rate limitations, all SDI Universal Accelerometers are capable of driving over 2000 feet (600 meters) of cable. However, at some length ranging between 50 feet and 2000 feet, each device will likely begin to exhibit oscillation.

ALTERNATIVE MODELS

SDI's High-Performance 1- Axis MEMS Accelerometers, the Silicon Designs Models 2220 and 2276, and come in two sizes to complement the triaxial configurations.



The high-performance SDI Models 2220 and 2276 are the single axis versions of the 2470 and 2476 with similarly upgraded SDI accelerometer chips, improved bias and scale factor temperature shift performance, and include an initial calibration certificate.



The 2220 comes in a traditional 1-inch square package with an integrated cable. It is operationally identical to the 2276, the small footprint accelerometer designed for tight spaces.

2470 DIMENSIONS

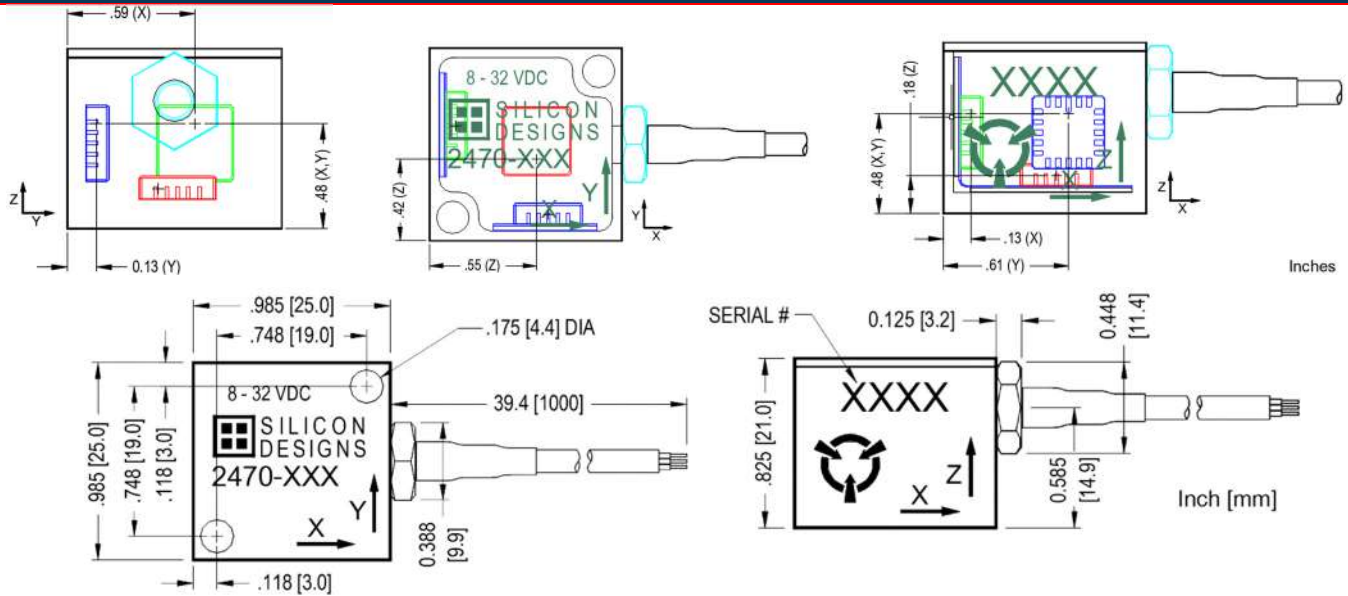

2476 DIMENSIONS

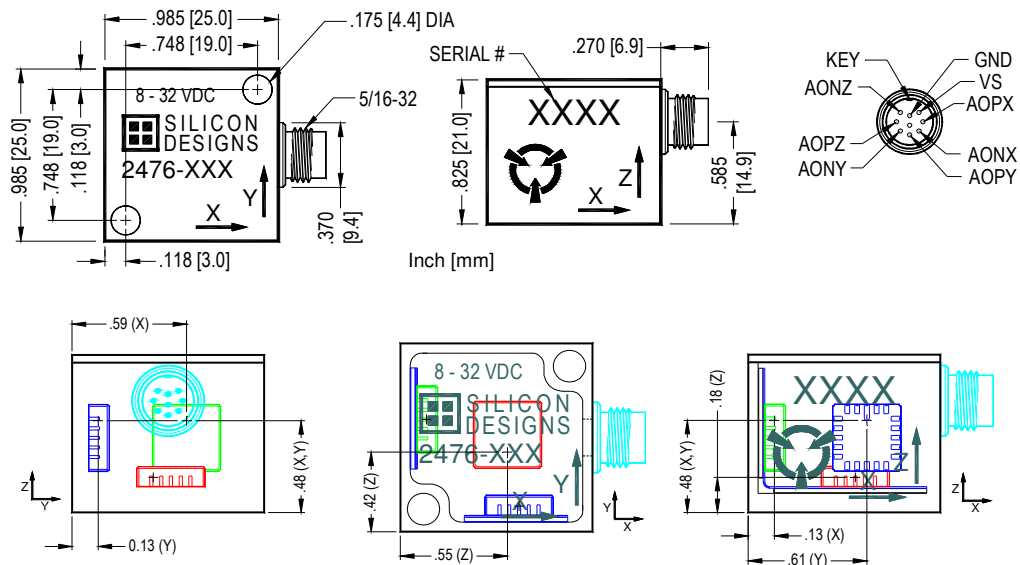

All measurements are in inches

Data sheets dated 1-November-2015 and newer apply to 2470 and 2476 serial numbers above 2000.
Contact SDI for data sheets pertaining to prior parts with serial numbers below 2000.

SPECIFICATIONS SUBJECT TO CHANGE WITHOUT NOTICE

CALIBRATION REPORT EXAMPLES

LINEARITY, PHASE & FREQUENCY RESPONSE BY G-LEVEL

The optional calibration reports provide additional information about the linearity, output, phase, and frequency response as tested for each individual unit. The following are examples of the graphical data supplied on calibration reports, by G-level.

EXAMPLE 2G

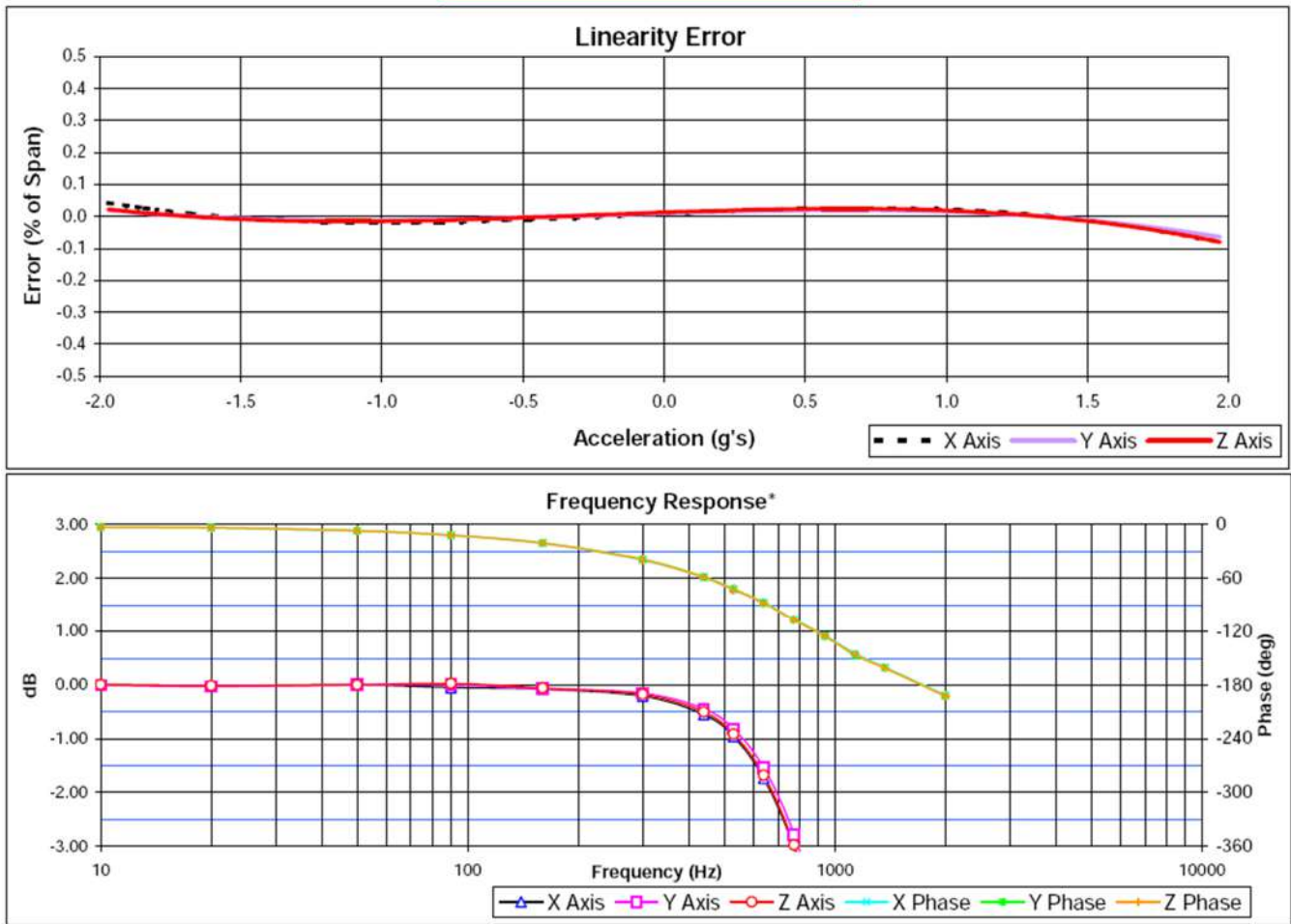

SPECIFICATIONS SUBJECT TO CHANGE WITHOUT NOTICE

EXAMPLE 5G

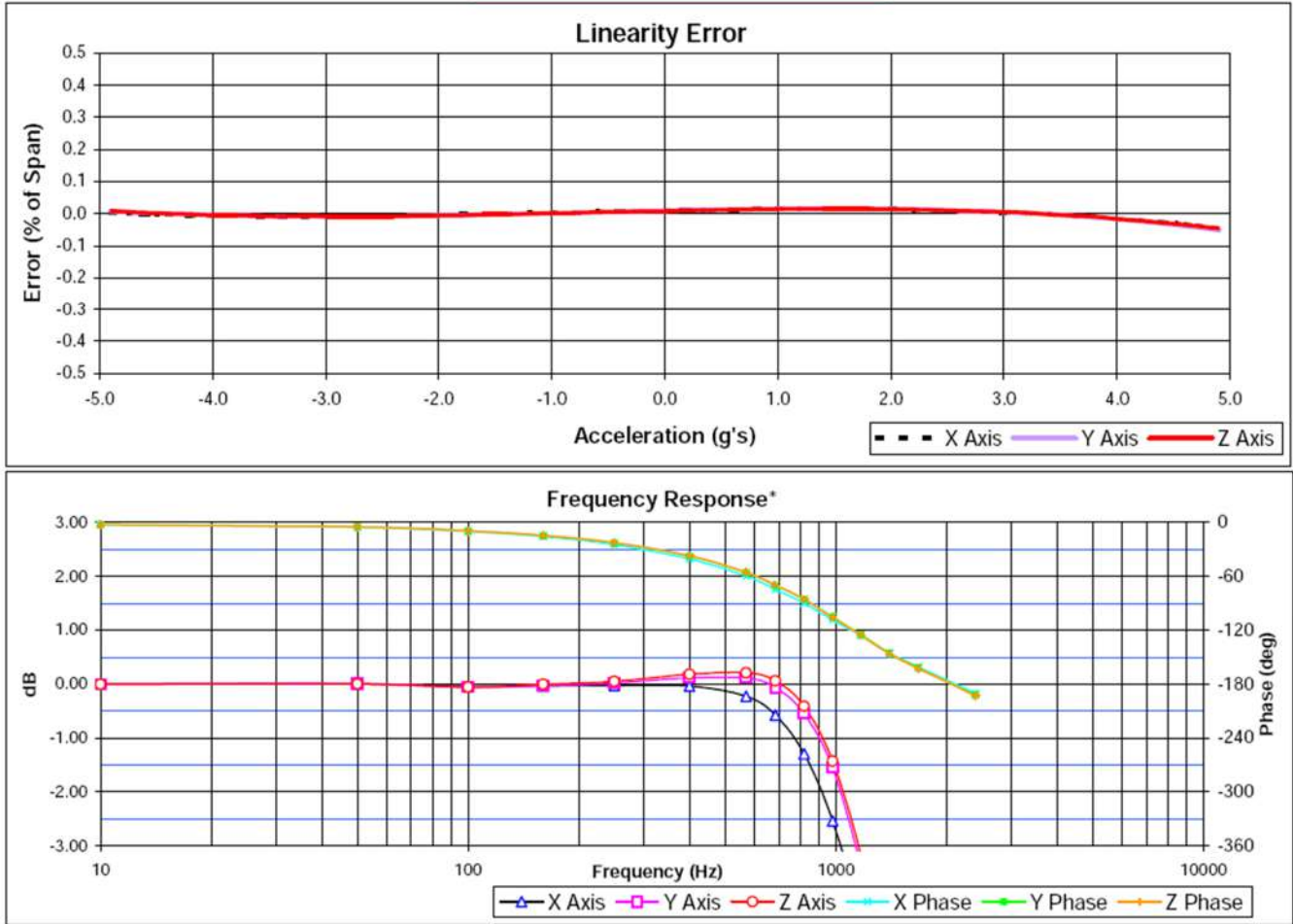

SPECIFICATIONS SUBJECT TO CHANGE WITHOUT NOTICE

EXAMPLE 10G

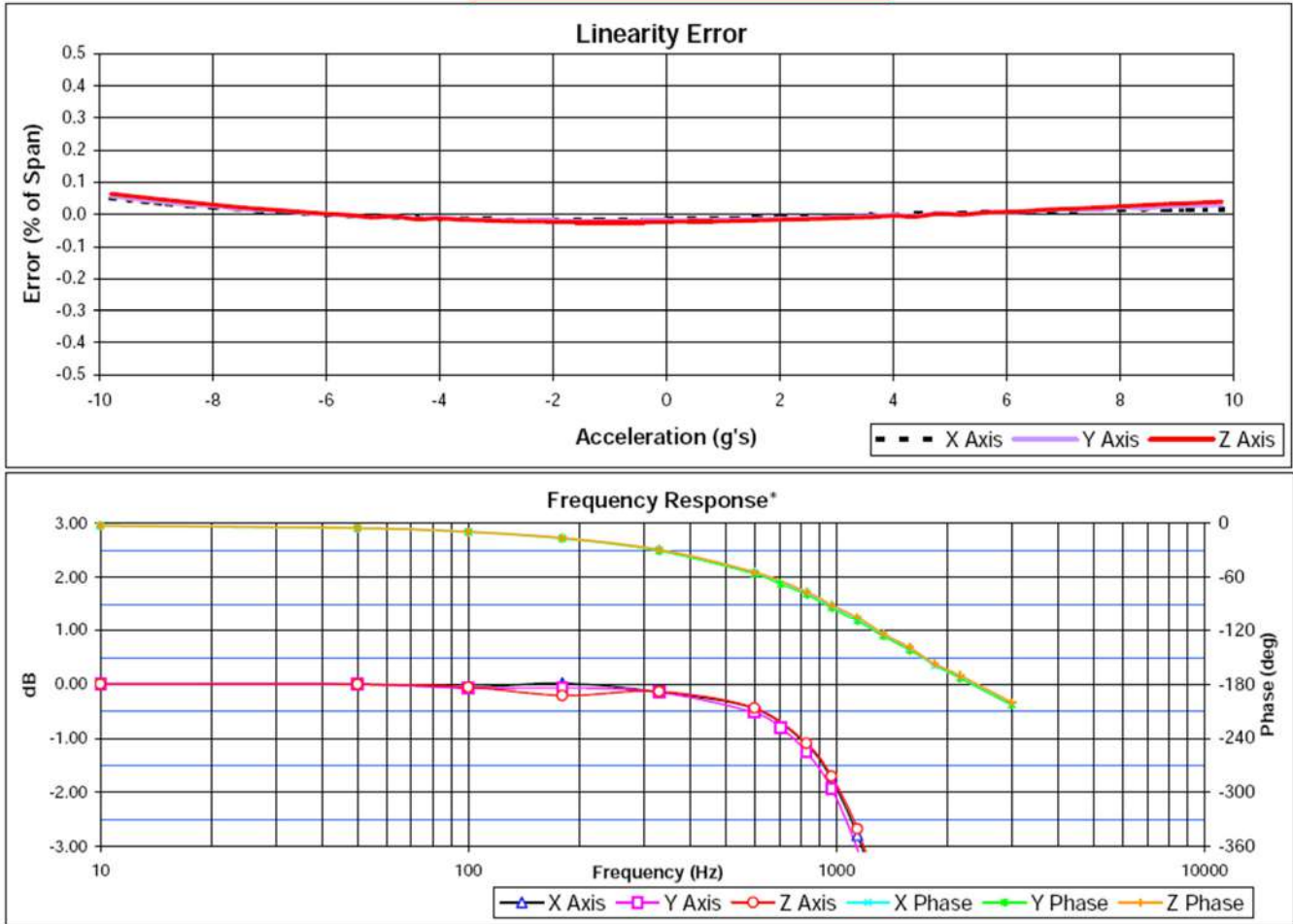

SPECIFICATIONS SUBJECT TO CHANGE WITHOUT NOTICE

EXAMPLE 25G

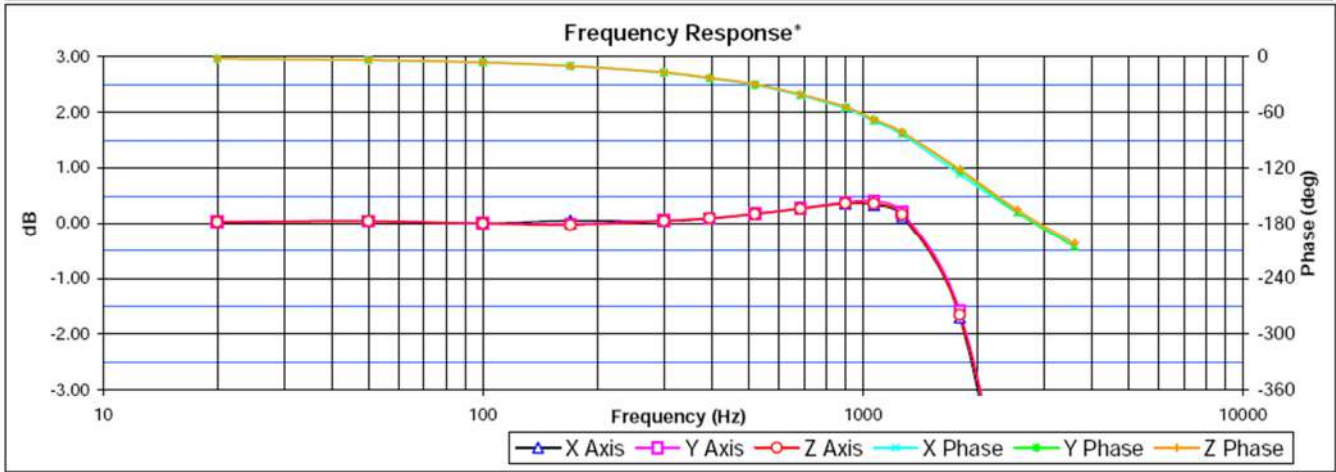
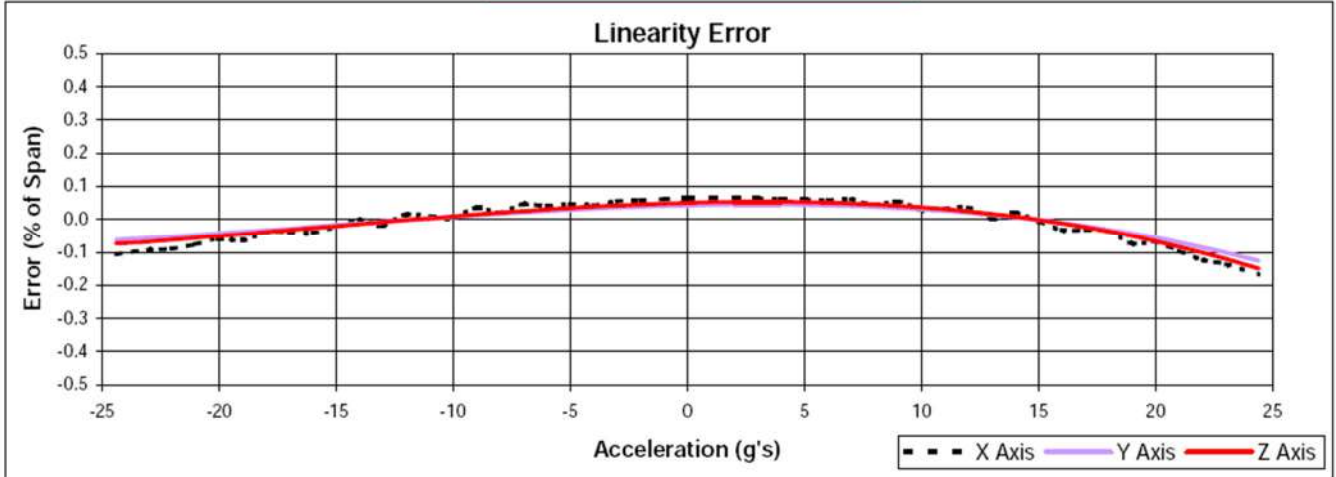

SPECIFICATIONS SUBJECT TO CHANGE WITHOUT NOTICE

EXAMPLE 50G

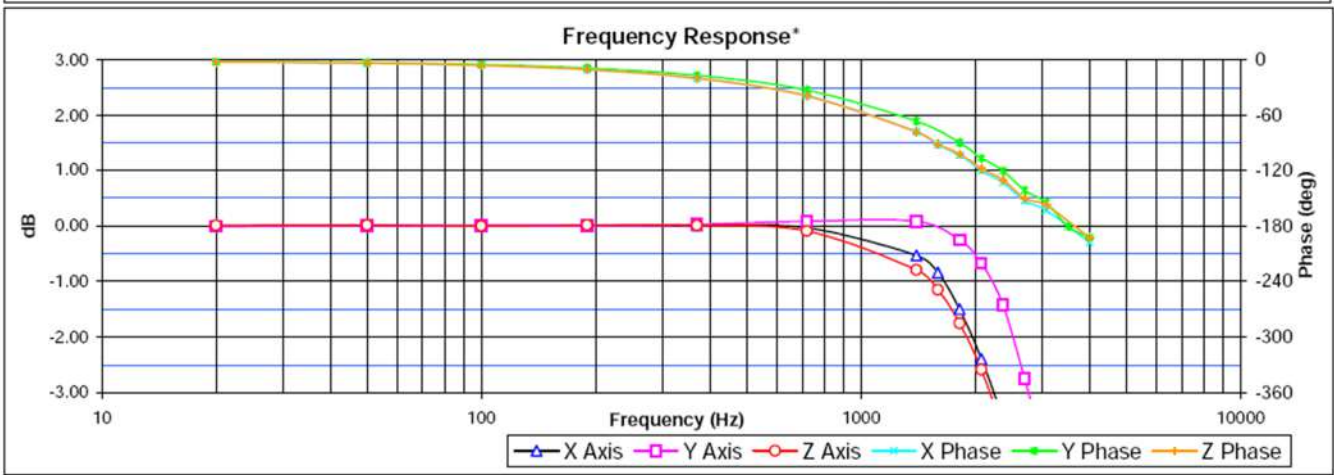
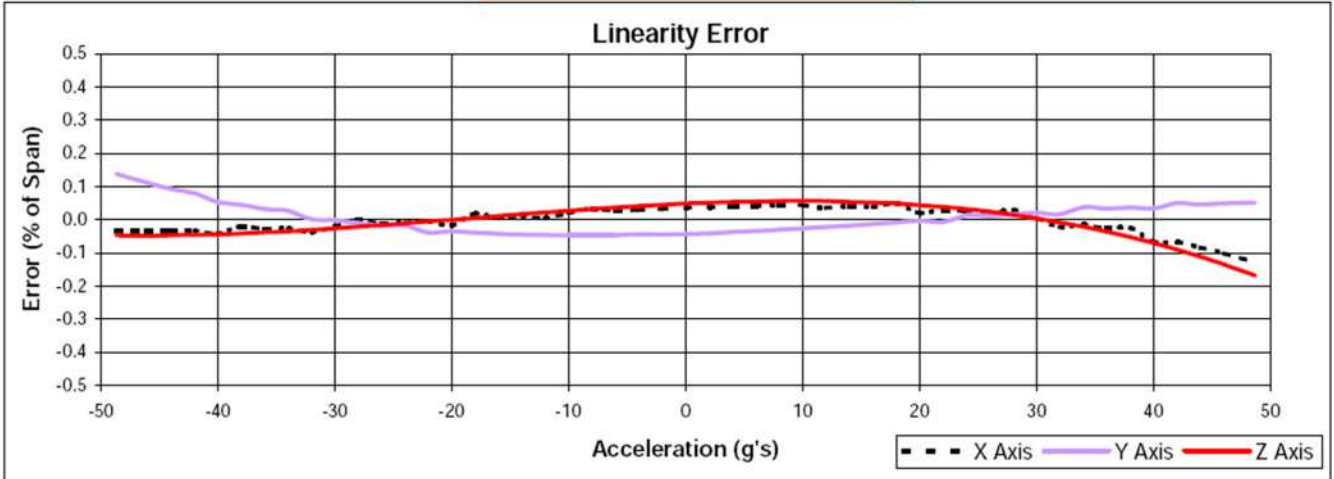

SPECIFICATIONS SUBJECT TO CHANGE WITHOUT NOTICE

EXAMPLE 100G

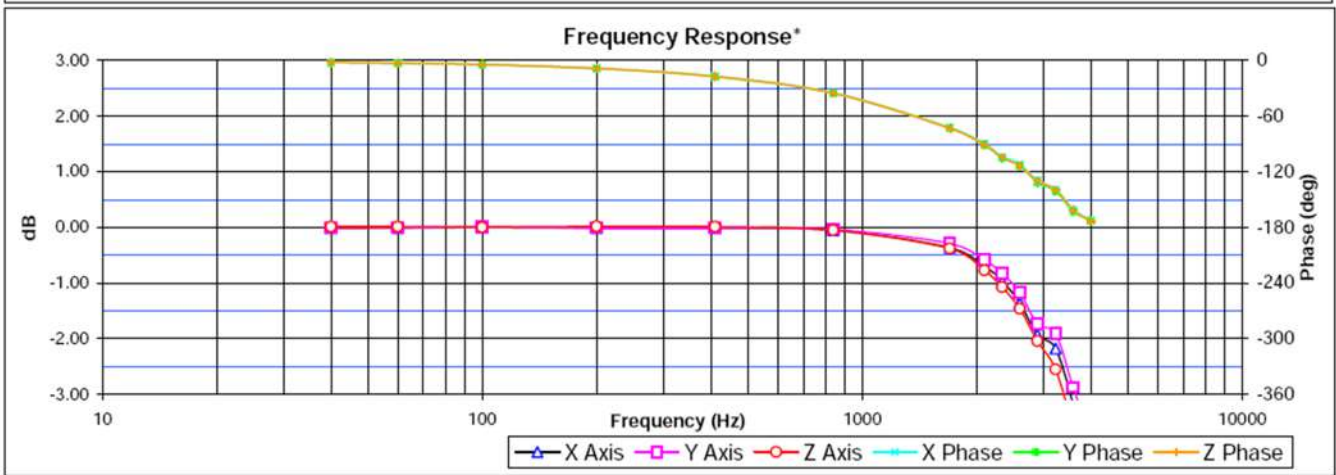
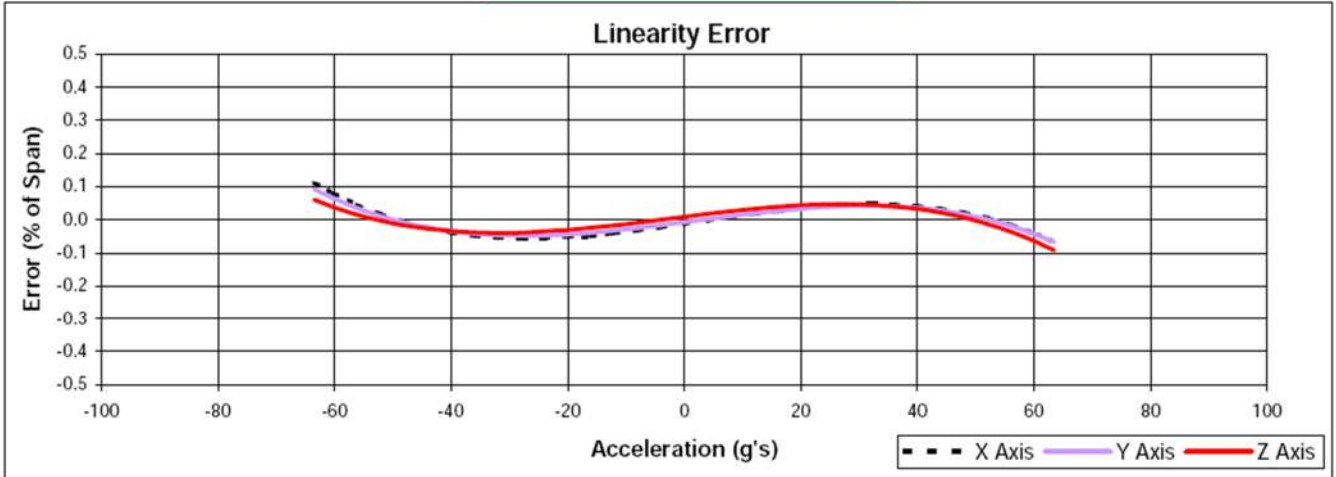

SPECIFICATIONS SUBJECT TO CHANGE WITHOUT NOTICE

EXAMPLE 200G

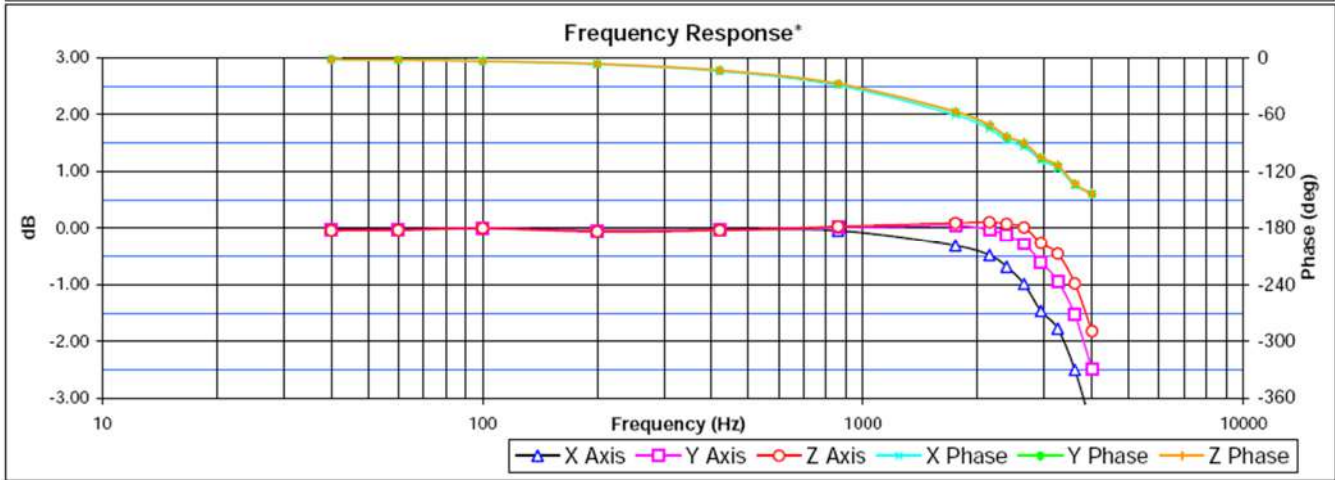
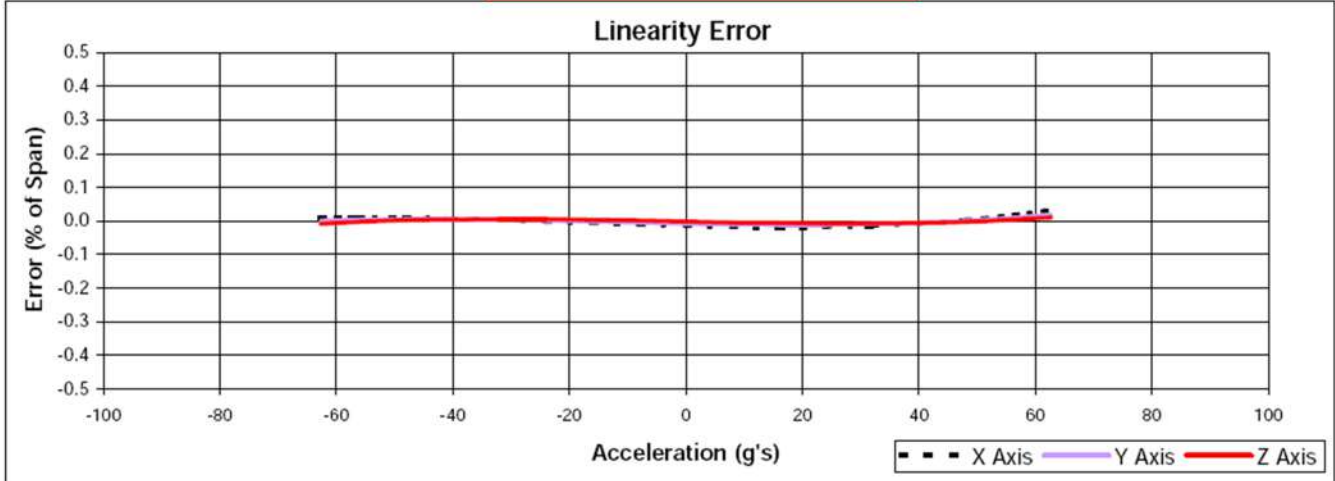

SPECIFICATIONS SUBJECT TO CHANGE WITHOUT NOTICE

EXAMPLE 400G

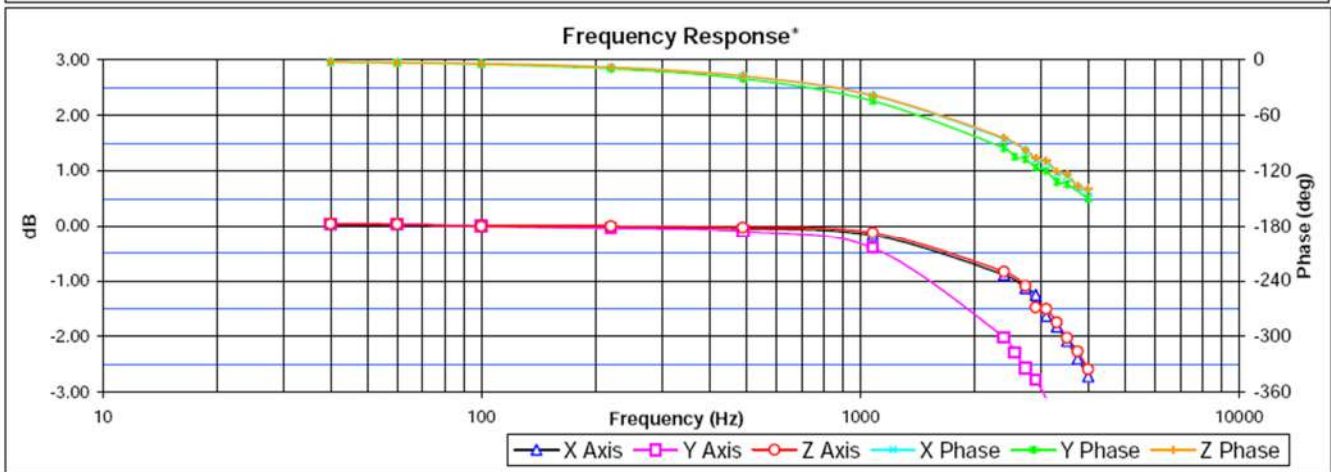
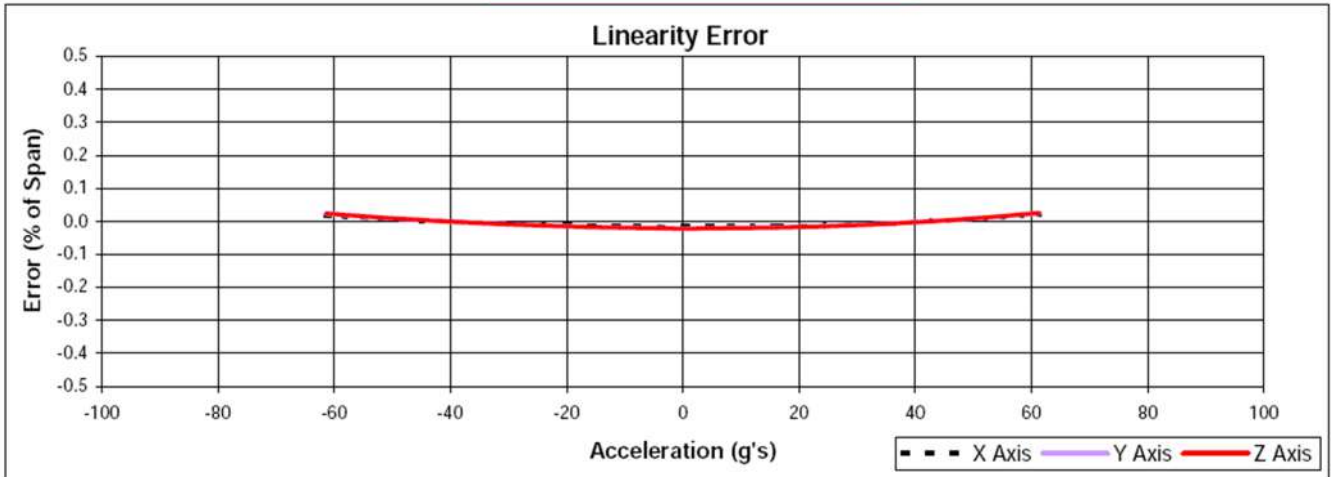

SPECIFICATIONS SUBJECT TO CHANGE WITHOUT NOTICE