

- Low Noise: 10  $\mu\text{g}/\text{Hz}$  Typical for  $\pm 2\text{g}$  Full Scale Versions
- -55 to +125°C Operating Temperature Range
- +5 VDC Power for Low Voltage Power Supply Systems
- Excellent Long-Term Stability
- $\pm 4\text{V}$  Differential Output or 0.5V to 4.5V Single Ended Output
- Responds to frequencies from zero (DC) to 2000+ Hz
- Integrated 3' Shielded Cable
- Simple Four (4) or Eight (8) Wire Connections
- Rugged Anodized Aluminum Case
- Fully Calibrated and Serialized for Traceability

AVAILABLE G-RANGES	
FULL SCALE ACCELERATION	MODEL SUFFIX
$\pm 2\text{ g}$	-002
$\pm 5\text{ g}$	-005
$\pm 10\text{ g}$	-010
$\pm 25\text{ g}$	-025
$\pm 50\text{ g}$	-050
$\pm 100\text{ g}$	-100
$\pm 200\text{ g}$	-200
$\pm 400\text{ g}$	-400

**SPECIALTY +5 V DC LOW VOLTAGE ACCELEROMETER MODELS 2012 & 2422**



SDI's Models 2012 and 2422 are Low Cost Single-Axis MEMS Variable Capacitive Accelerometers are rugged plug-and-play measurement devices for suitable for a wide array of demanding applications. Both models only require a steady +5 V DC Power Supply to support industrial-grade sensing on acquisition systems with limited power supply options.

The 2012 and 2422 feature an integrated 3' cable, and both models feature one (1) or three (3) hermetically sealed, low noise SDI surface mount accelerometers, which are individually tested, programmed, and calibrated by SDI.

The 2012 and 2422 are relatively insensitive to temperature changes and gradients between -55 and +125°C. The cable's shield is electrically connected to the case while the ground (GND) wire is isolated from the case. The robust, anodized aluminum case is epoxy sealed and can be mounted easily via two screws, an adhesive, or by attaching a magnet.



**ZERO (DC) TO MEDIUM FREQUENCY APPLICATIONS**



**PERFORMANCE BY G RANGE**

INPUT RANGE	SENSITIVITY, DIFFERENTIAL	*FREQUENCY RESPONSE (TYPICAL, 5%)	*FREQUENCY RESPONSE (TYPICAL, 3 DB)	*FREQUENCY RESPONSE (MINIMUM, 3 DB)	OUTPUT NOISE, DIFFERENTIAL (RMS, TYPICAL)	MAX. MECHANICAL SHOCK (0.1 MS)
g	mV/g	Hz	Hz	Hz	$\mu\text{g}/(\text{root Hz})$	g (peak)
$\pm 2$	2000	0 - 250	0 - 525	0 - 300	10	2000
$\pm 5$	800	0 - 400	0 - 800	0 - 420	15	
$\pm 10$	400	0 - 700	0 - 1100	0 - 660	23	
$\pm 25$	160	0 - 1300	0 - 1750	0 - 1050	38	
$\pm 50$	80	0 - 1600	0 - 2100	0 - 1400	60	5000
$\pm 100$	40	0 - 1700	0 - 3000	0 - 1700	121	
$\pm 200$	20	0 - 1900	0 - 3600	0 - 2100	243	
$\pm 400$	10	0 - 2000	0 - 4200	0 - 2400	475	

By Model:  $V_{DD}=V_R=5.0\text{ VDC}$ ,  $T_C=25^\circ\text{C}$

*Single ended sensitivity is half of values shown.*

SPECIFICATIONS SUBJECT TO CHANGE WITHOUT NOTICE

## PERFORMANCE - ALL VERSIONS

All Models: Unless otherwise specified, Vs=+8 to +32 VDC, TC=25°C, Differential Mode. Span = ±g range = 8000 mV.

PARAMETER	MIN	TYP	MAX	UNITS
Bias Calibration Error (%)		0.25	0.6	± % of span
Bias Calibration Error (mV)		25	60	± mV
Scale Factor Calibration Error <sup>1</sup>		0.5	1.25	± %
Non-Linearity (-90 to +90% of span) <sup>1</sup>		0.15	0.5	± % of span
Bias Temperature Shift (Coefficient)	-200	0	+200	(PPM of span)/°C
Scale Factor Temperature Shift (Coefficient)	-200	0	+200	PPM/°C
Cross Axis Sensitivity		2	3	± %
Power Supply Rejection Ratio		25		dB
Operating Temperature	-55		+125	°C
Output Impedance (2012/2422)		90/1		Ω
Output Common Mode Voltage		2.5		VDC
Operating Voltage	4.75	5.0	5.25	VDC
Operating Current (AOP & AON open, 2012/2422)		8/21	10/30	mA DC
Mass 2012/2422		8/21		grams
Cable Mass (3' integrated cable, 2012/2422)		14/25		grams/meter

Note 1: For 2g thru 50g only; 100g and greater versions are tested and specified from -65 to +65g.

NOTICE: Stresses greater than those listed may cause permanent damage to the device. These are maximum stress ratings only. Functional operation of the device at or above these conditions is not implied.

## OPERATION

SDI Models 2012 & 2422 MEMS Variable Capacitive Accelerometers provide optimal performance when they are connected to instrumentation in a differential configuration using both the AOP and AON output signals, but they also support single ended operation for complete flexibility.

These Accelerometers produce differential analog output voltage pairs (AON & AOP) which vary with acceleration. The signal outputs are fully differential about a common mode voltage of approximately 2.5 volts. At zero acceleration, the output differential voltage is nominally 0 volts DC; at ±full scale acceleration, the output is ±4 volts DC, respectively, as shown in the figure (below). The output scale factor is independent from the supply voltage of +5 volts.

When a differential connection is not possible, SDI recommends connecting the accelerometer to instrumentation in single ended mode by connecting AOP and GND to the instrumentation and leaving AON disconnected. Keep in mind that the signal to noise ratio is reduced by half for a single-ended vs. a differential connection.

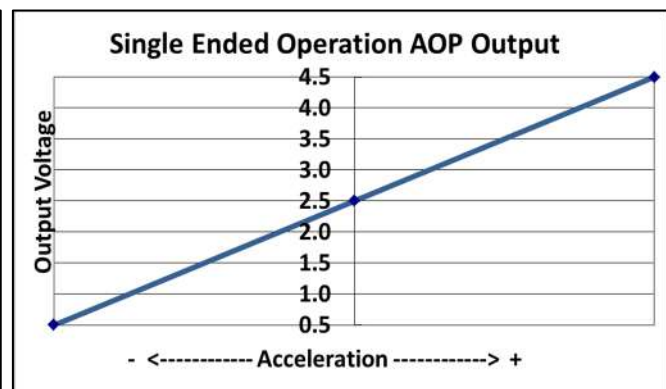
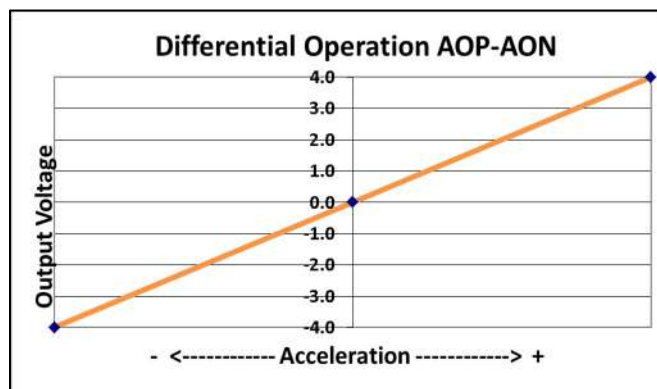

SPECIFICATIONS SUBJECT TO CHANGE WITHOUT NOTICE

**CABLE SPECIFICATIONS**

Model 2012: The standard 3' integrated cable consists of four 28 AWG (7x36) tin-plated copper wires with Teflon FEP insulation surrounded by a 40 AWG tin plated copper braided shield. The shield jacket is Teflon FEP with a nominal outer diameter of 0.096". The cable's braided shield is electrically connected to the case. The black ground (GND) wire is isolated from the case.

Model 2422: The SDI 2422 has an integrated 1-meter (approx. 3 feet) cable with strain relief attached at the connection to the case and consists of seven 28 AWG (7x36) and one 26 AWG (7x34) tin-plated copper wires. The seven smaller 28 AWG wires are covered by 5.5 mils of Teflon FEP insulation. The large single 26 AWG wire is covered by 8.5 mils of black Teflon FEP insulation. The seven smaller gauge wires surround the single larger gauge (black) wire. The cable's braided shield is electrically connected to the case. The black ground (GND) wire is isolated from the case. The wire bundle is surrounded by a braided shield and covered by a 10 mil thick Teflon FEP jacket with a nominal outer diameter of 0.136".

**CABLE LENGTH CONSIDERATIONS**

Extending the cable length is possible but not recommended on Models 2012 and 2422 due to the limited voltage.

**MODEL 2012 PACKAGE DIMENSIONS**

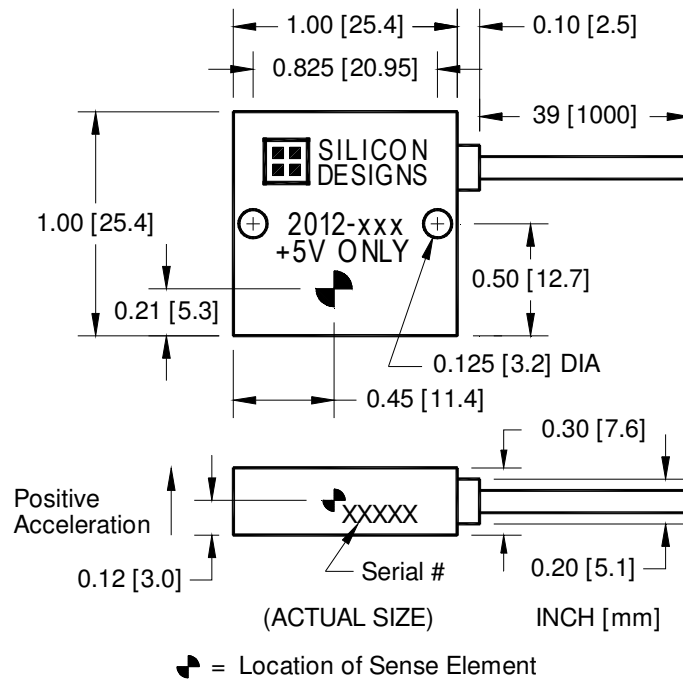

SPECIFICATIONS SUBJECT TO CHANGE WITHOUT NOTICE

MODEL 2422 PACKAGE DIMENSIONS

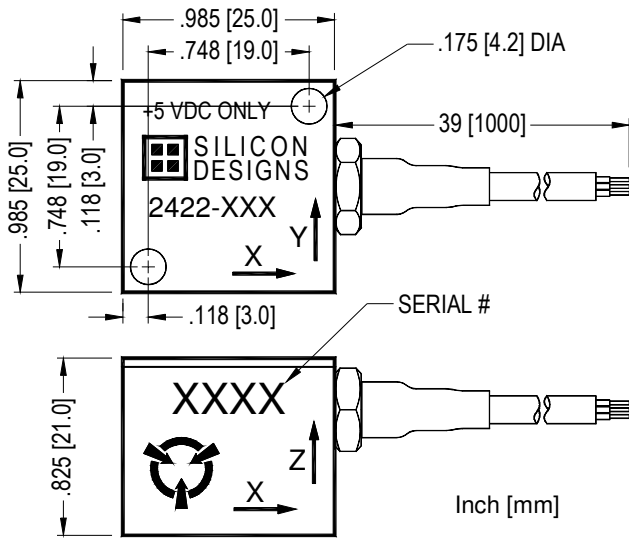

	For serial numbers:	
	up to 3000	after 3000
A(X)	0.61	0.58
B(X)	0.16	0.13
C(X)	0.59	0.55
A(Y)	0.16	0.13
B(Y)	0.59	0.60
C(Y)	0.59	0.55
A(Z)	0.54	0.37
B(Z)	0.64	0.60
C(Z)	0.22	0.18

dimensions in inches

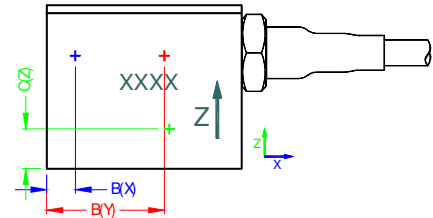
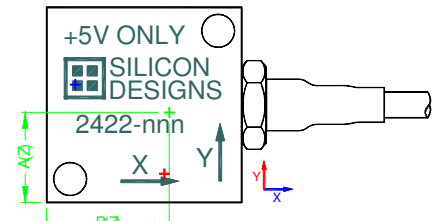
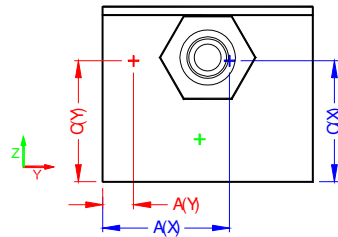

OPTIONAL ACCESSORIES

Model 2230 Triaxial Mounting Block



- Anodized 6061-T6 aluminum 1.25" cube
- Mix and Match g-levels for custom combinations

Model 2232 Magnetic Mount

- 10 lbs / 4.6 KG pull force
- Rated for use up to +/-50G
- Low mass: 23 grams



Model 2235 Stud Mount Adaptor Block

- Stud mount Adaptor for any SDI module
- Anodized 6061-T6 aluminum block
- 6.2 grams, 0.7" x 1" footprint



SPECIFICATIONS SUBJECT TO CHANGE WITHOUT NOTICE

RECOMMENDED CONNECTIONS - DIFFERENTIAL

SDI Models 2012 & 2422 MEMS Variable Capacitive Accelerometers provide optimal performance when they are connected to instrumentation in a differential configuration using both the AOP and AON output signals.

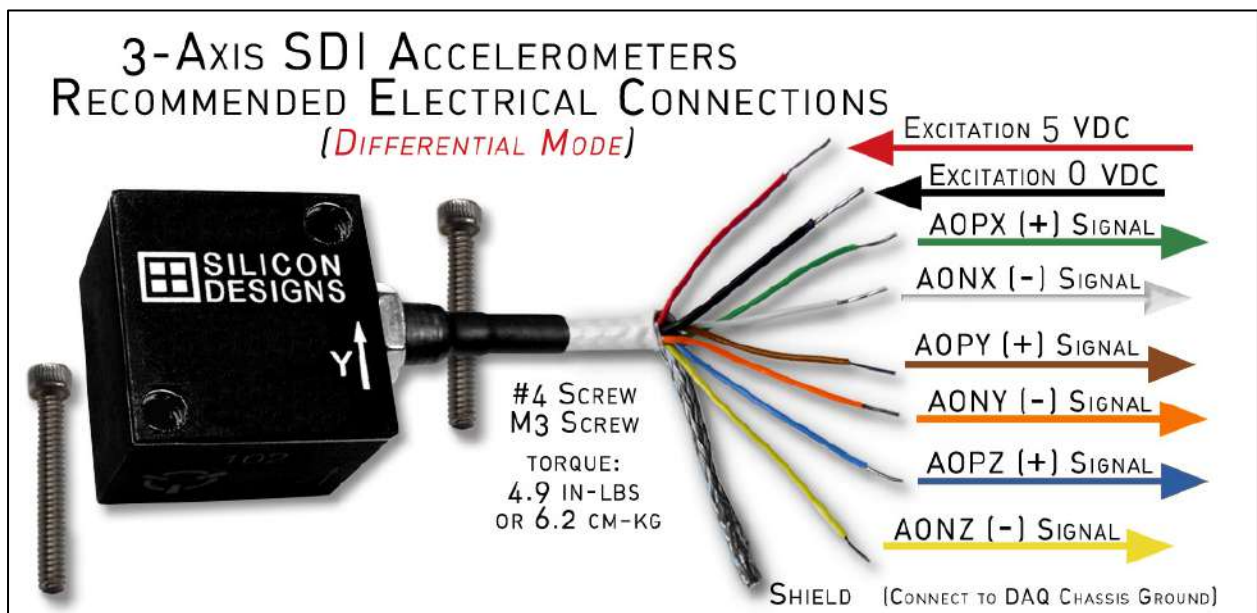
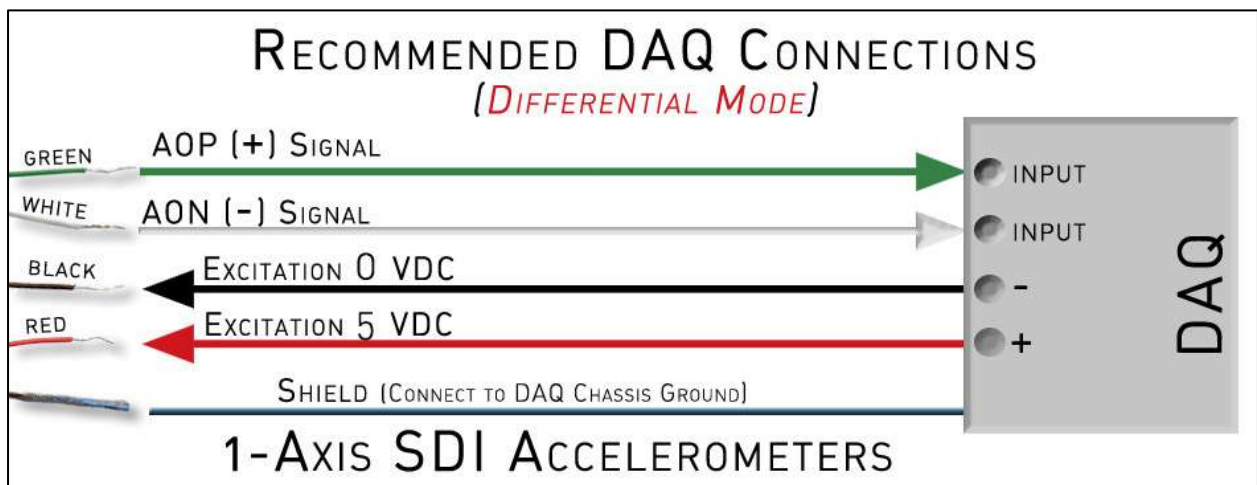
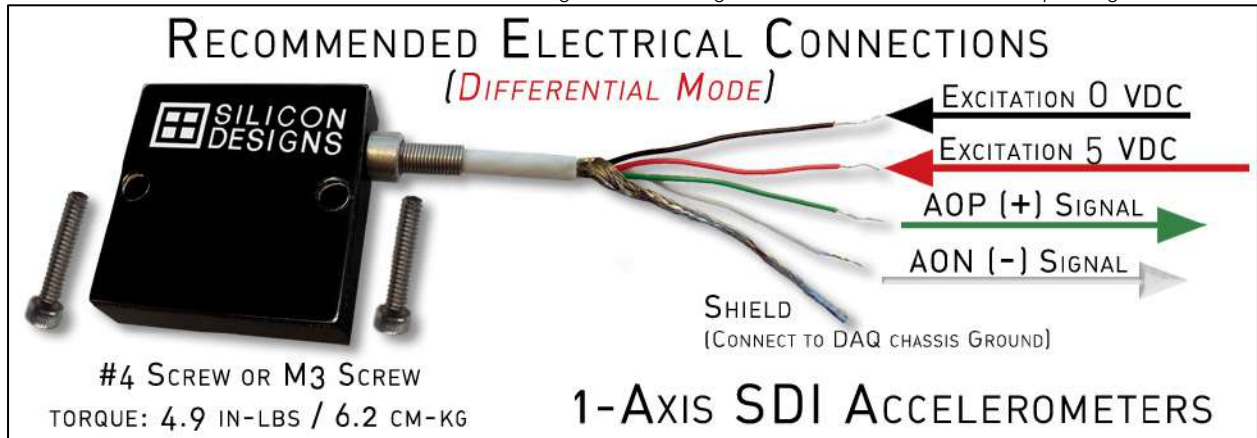

SPECIFICATIONS SUBJECT TO CHANGE WITHOUT NOTICE



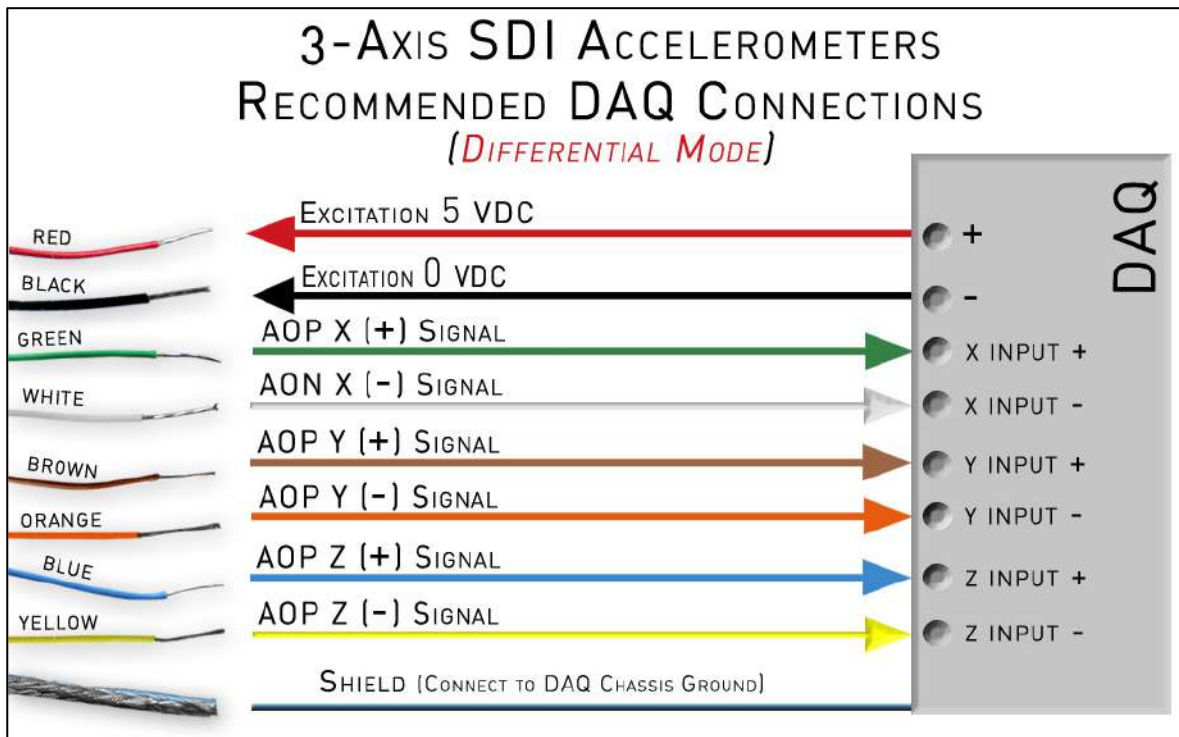

**RECOMMENDED CONNECTIONS - SINGLE ENDED**

Single ended operation is also possible with minor changes to the wiring configuration, as described below.

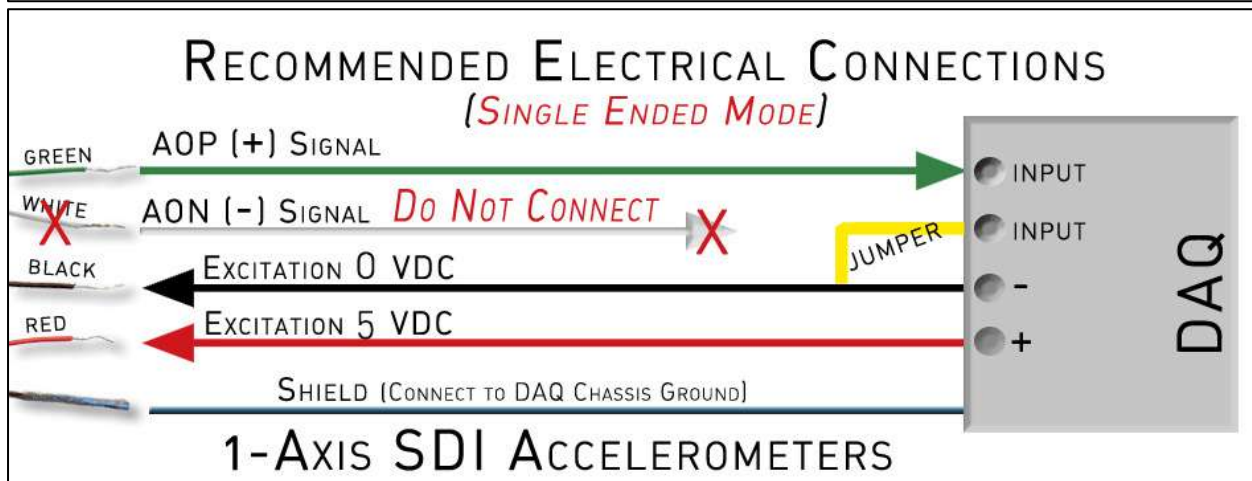
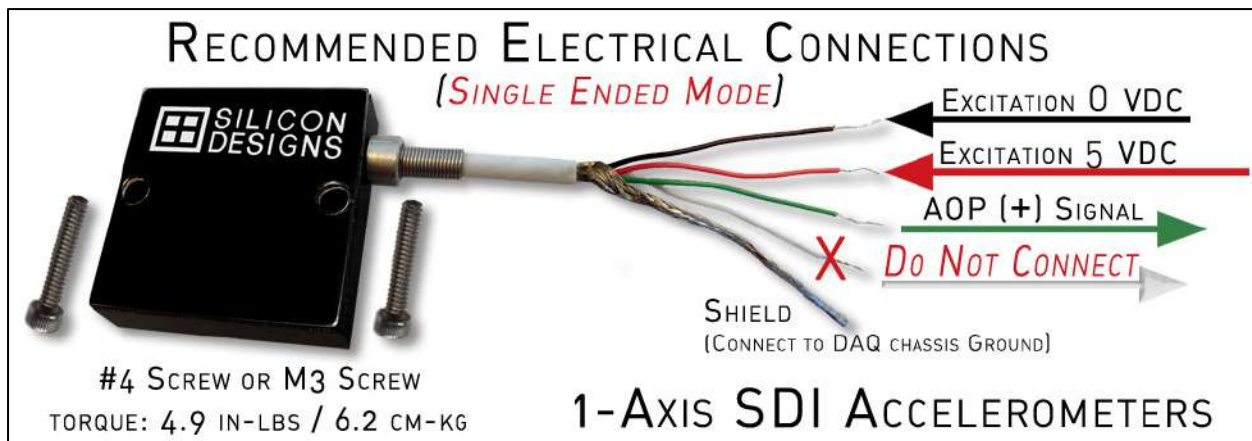

SPECIFICATIONS SUBJECT TO CHANGE WITHOUT NOTICE

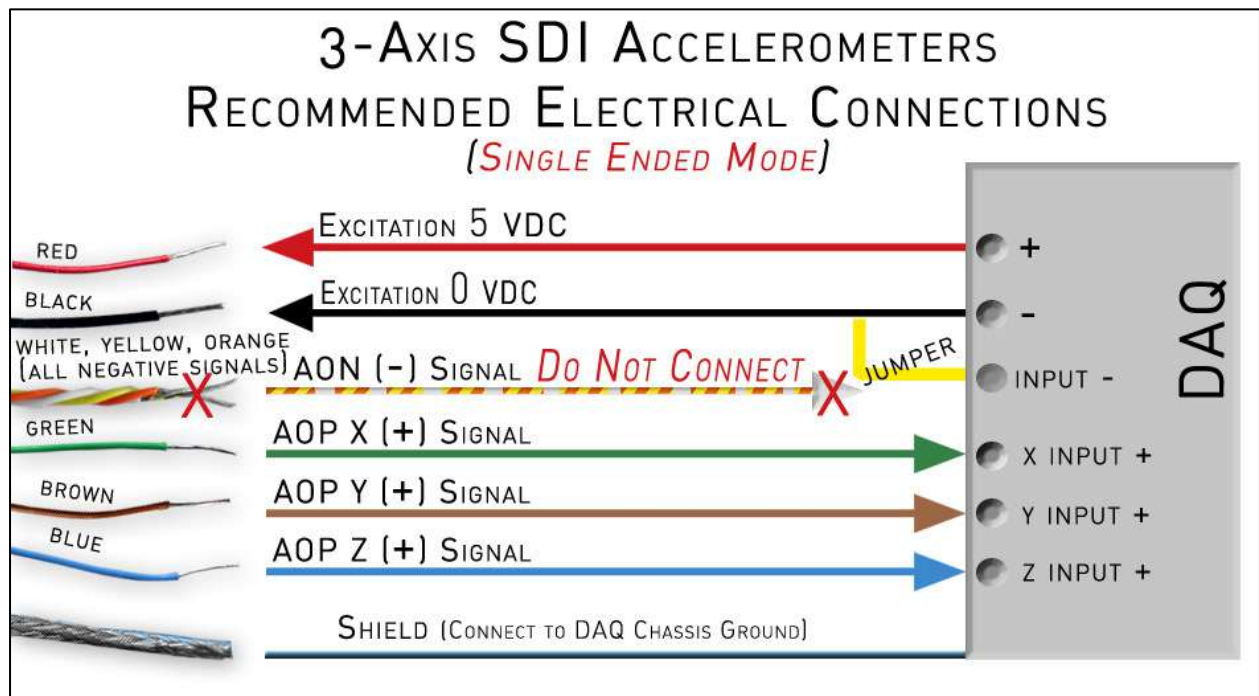
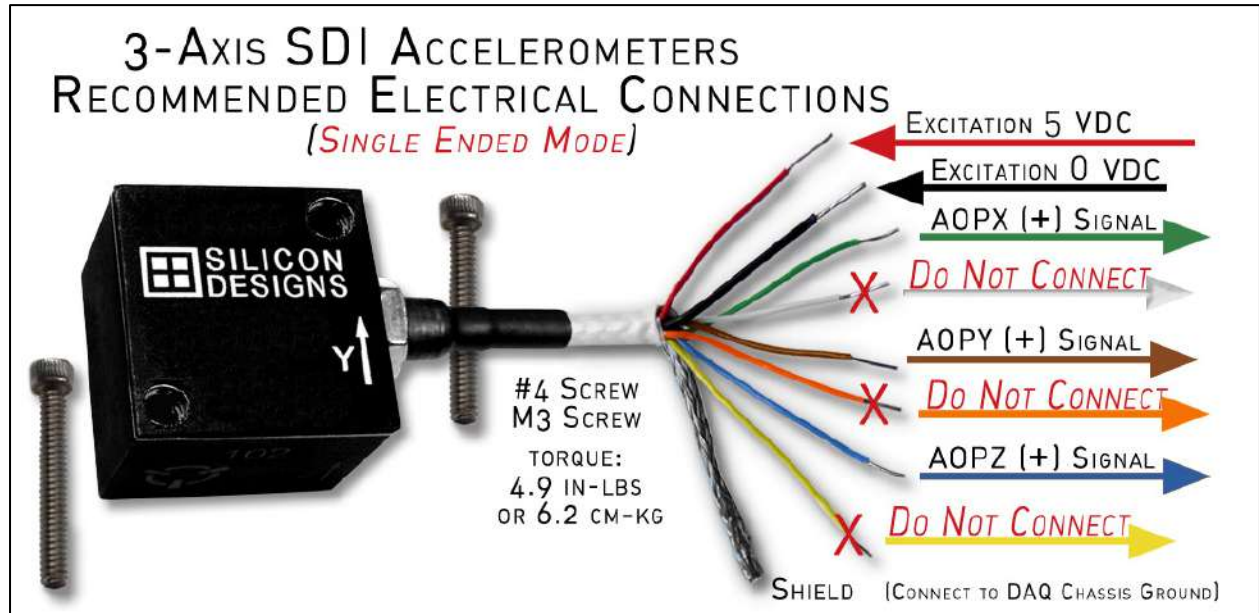

SPECIFICATIONS SUBJECT TO CHANGE WITHOUT NOTICE

**CALIBRATION REPORT EXAMPLES  
LINEARITY, PHASE & FREQUENCY RESPONSE BY G-LEVEL**

The optional calibration reports provide additional information about the linearity, output, phase, and frequency response as tested for each individual unit. The following are examples of the graphical data supplied on the Three-Axis Model 2422 calibration reports, by G-level. The Single-Axis Model 2012's reports are similar but only display one (1) channel in the charts.

**EXAMPLE 2G in 3-AXIS**

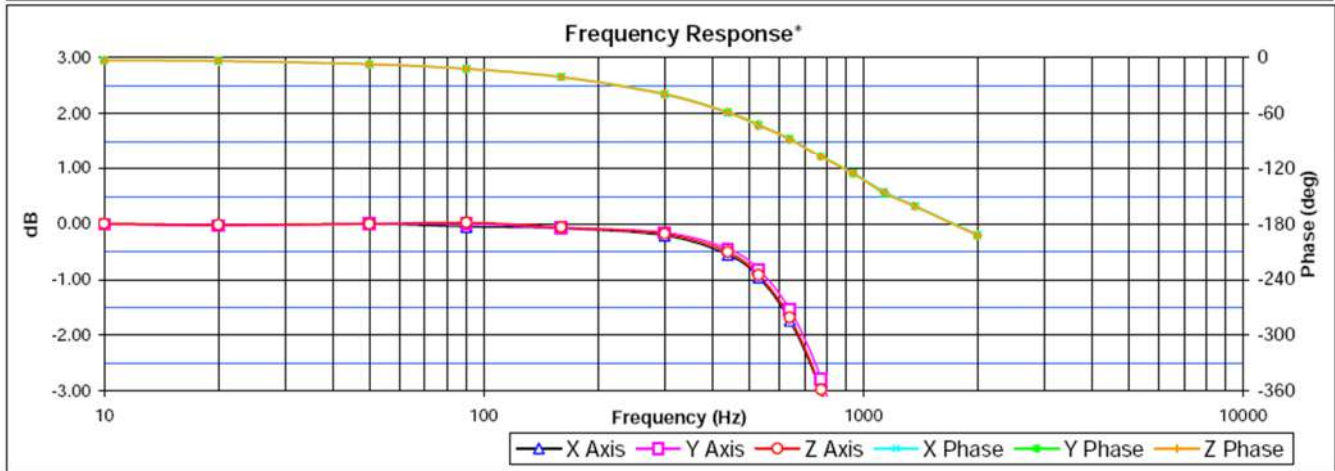
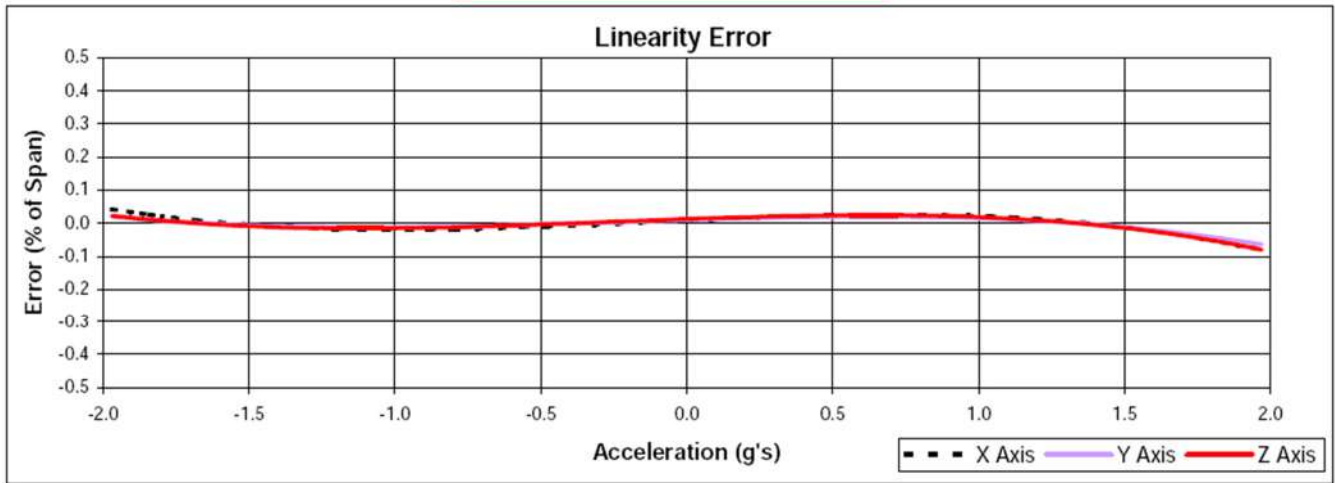



**EXAMPLE 5G in 3-AXIS**

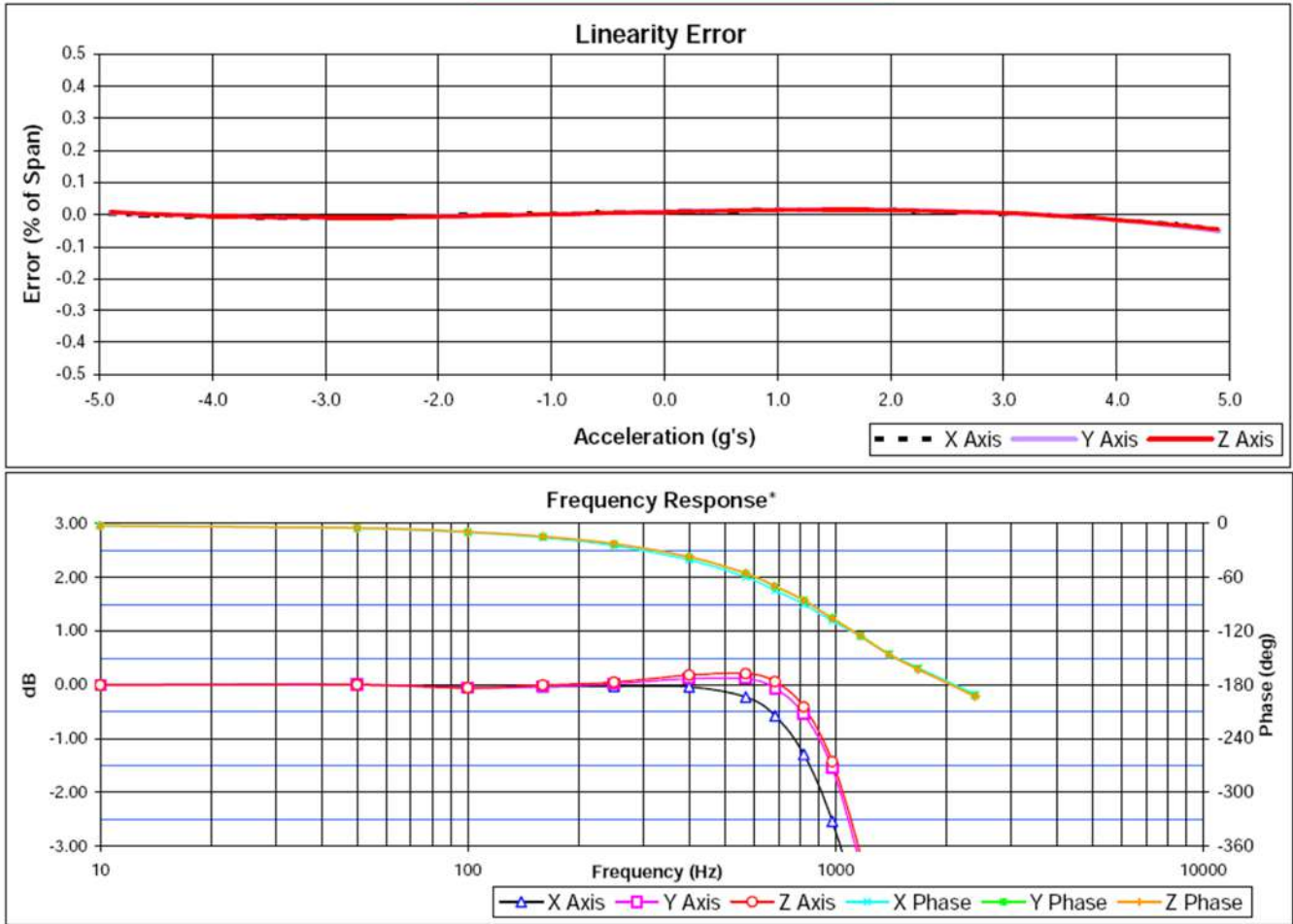

SPECIFICATIONS SUBJECT TO CHANGE WITHOUT NOTICE

**EXAMPLE 10G in 3-AXIS**

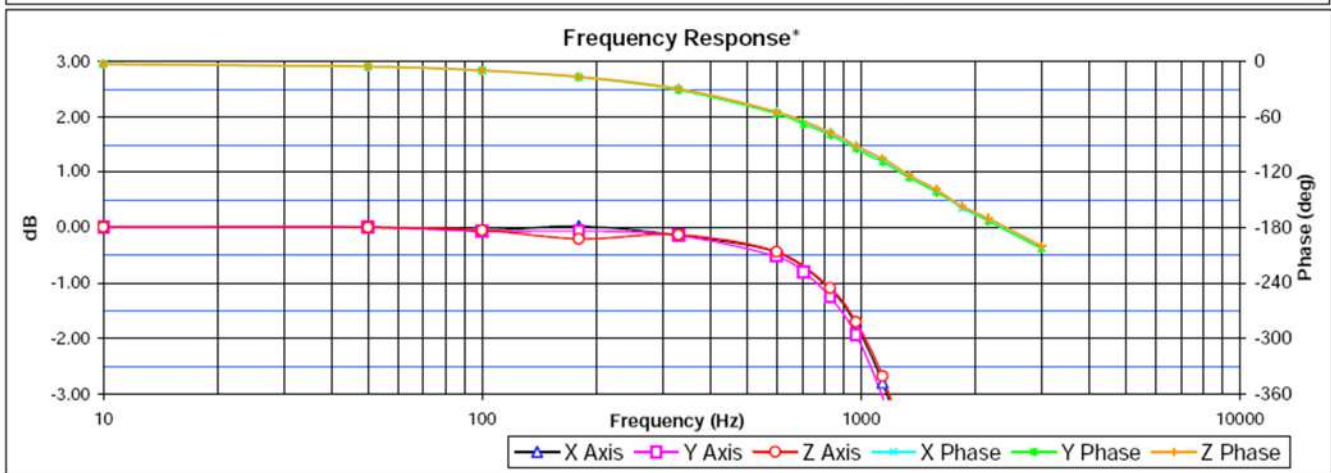
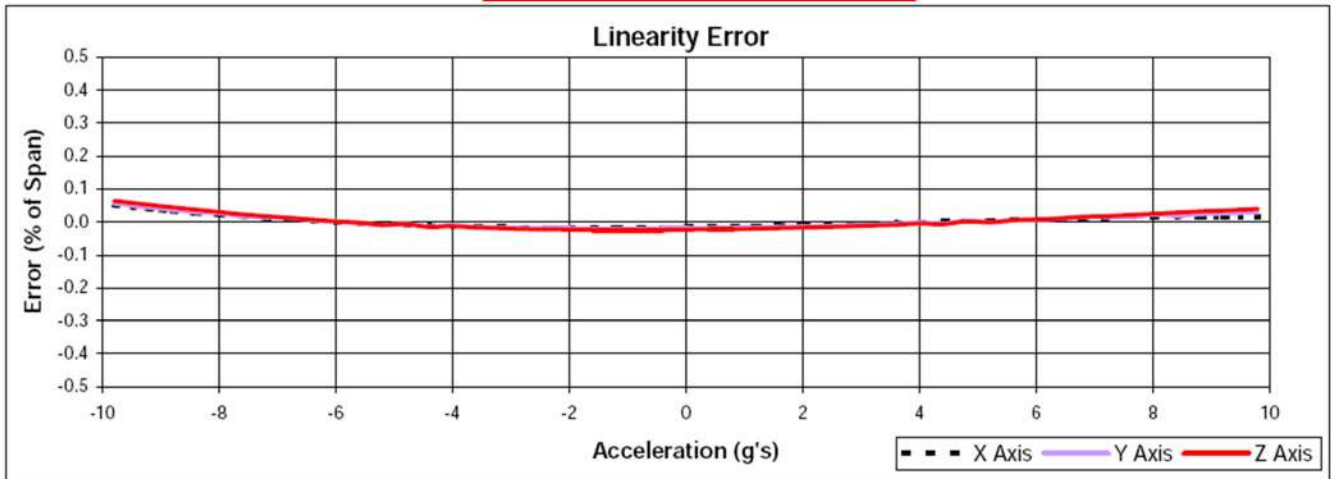

SPECIFICATIONS SUBJECT TO CHANGE WITHOUT NOTICE

**EXAMPLE 25G in 3-AXIS**

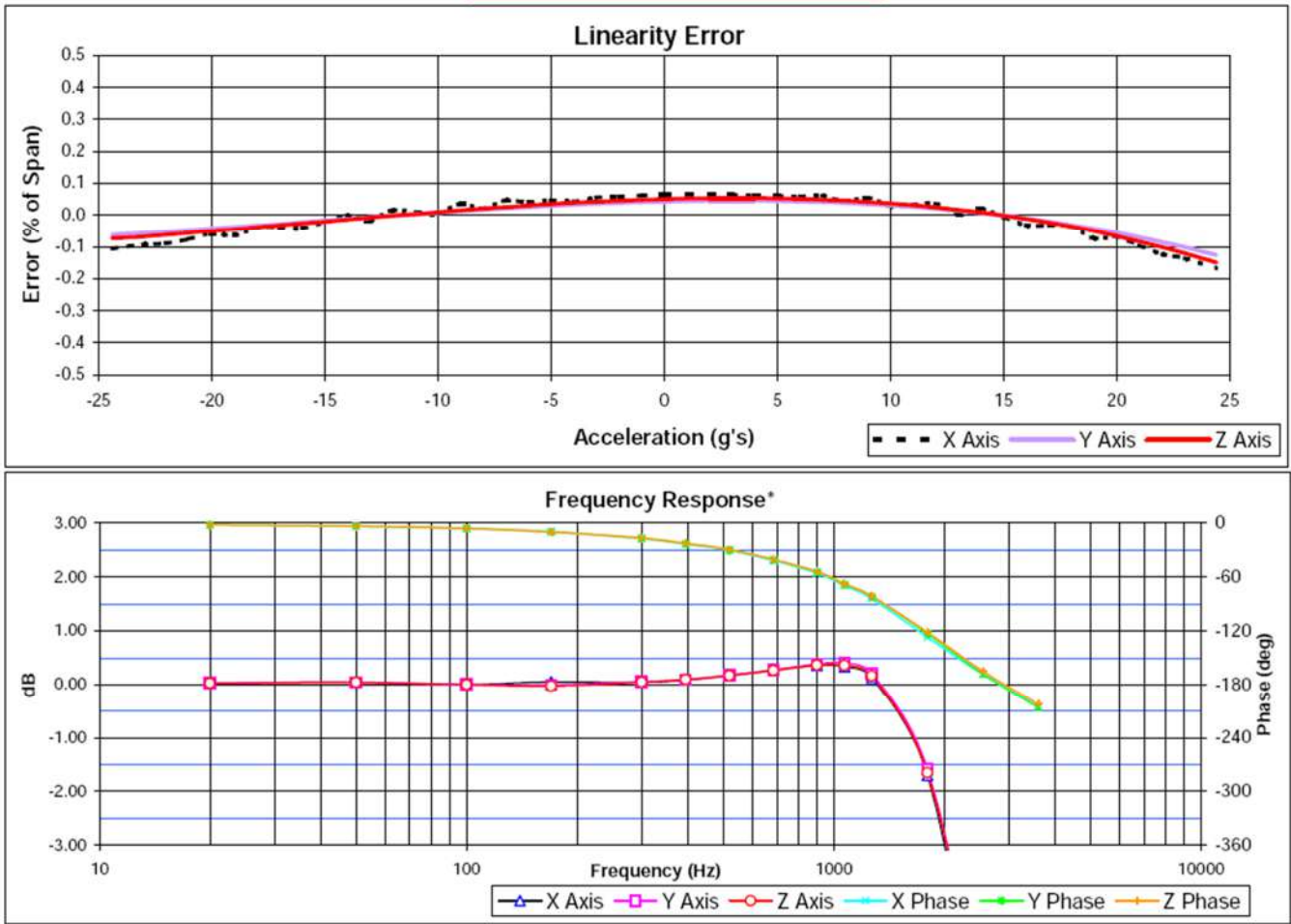

SPECIFICATIONS SUBJECT TO CHANGE WITHOUT NOTICE

EXAMPLE 50G in 3-AXIS

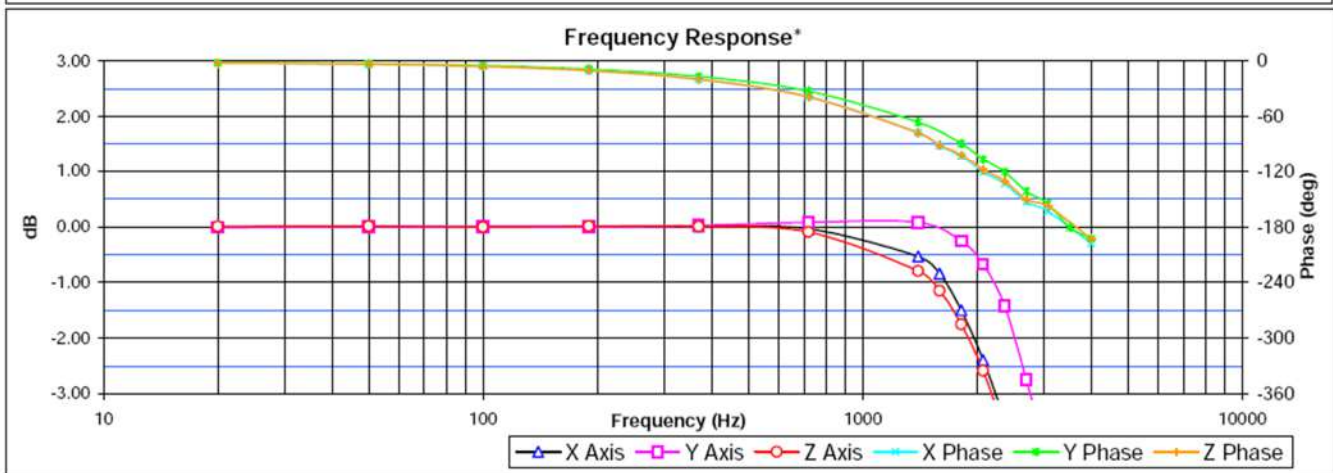
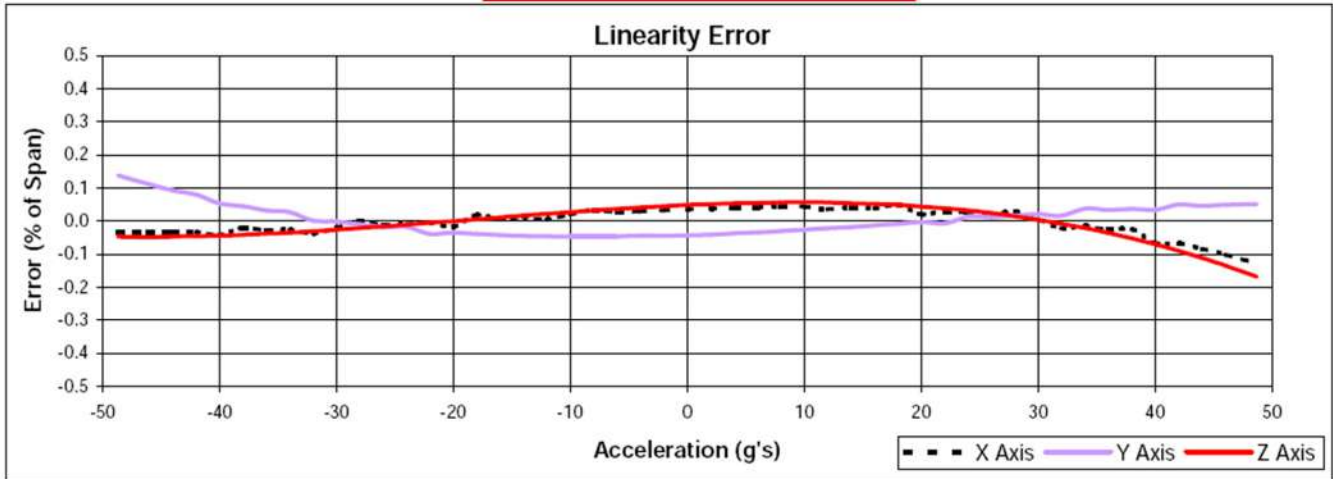

SPECIFICATIONS SUBJECT TO CHANGE WITHOUT NOTICE

**EXAMPLE 100G in 3-AXIS**

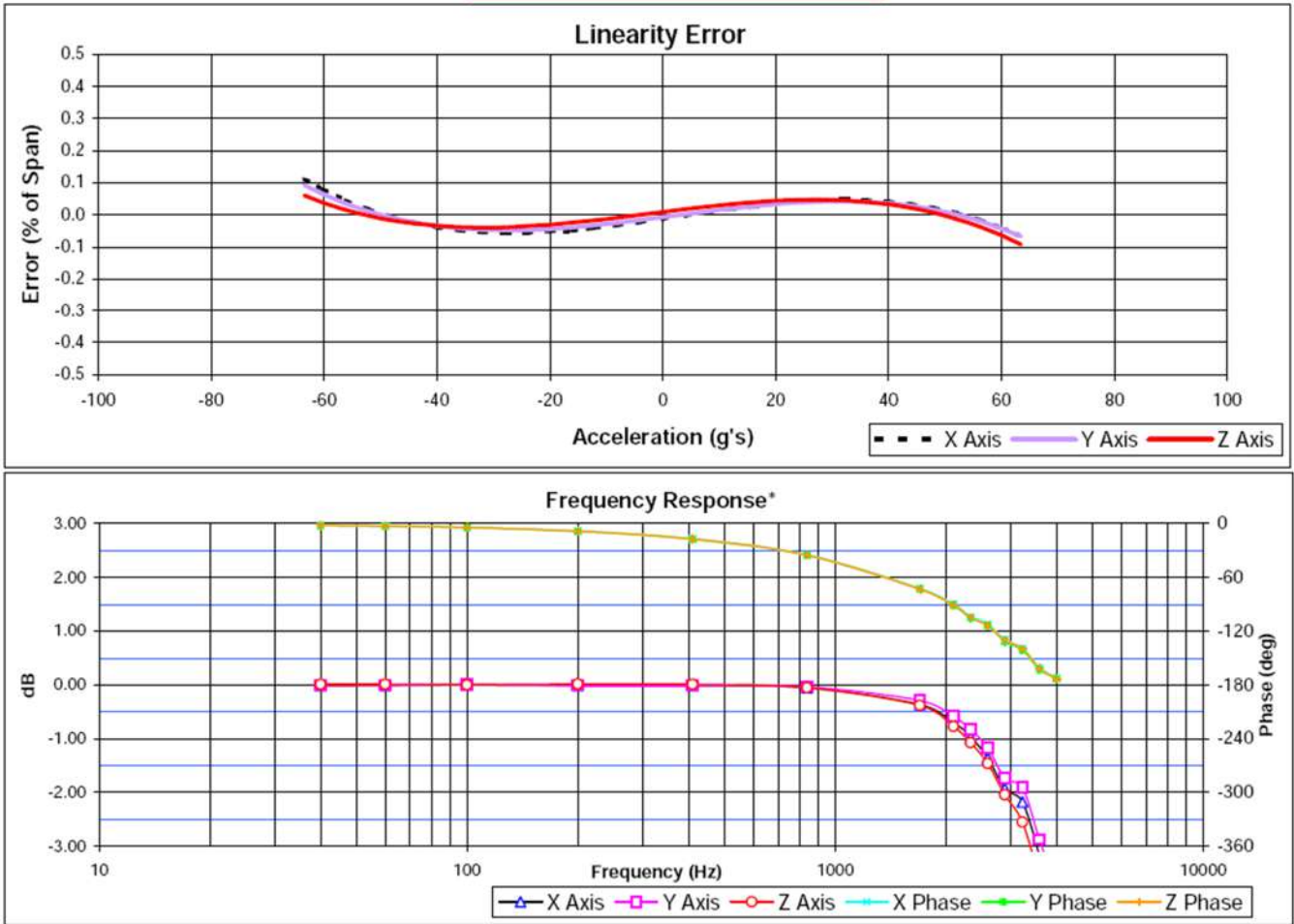

SPECIFICATIONS SUBJECT TO CHANGE WITHOUT NOTICE



EXAMPLE 200G in 3-AXIS

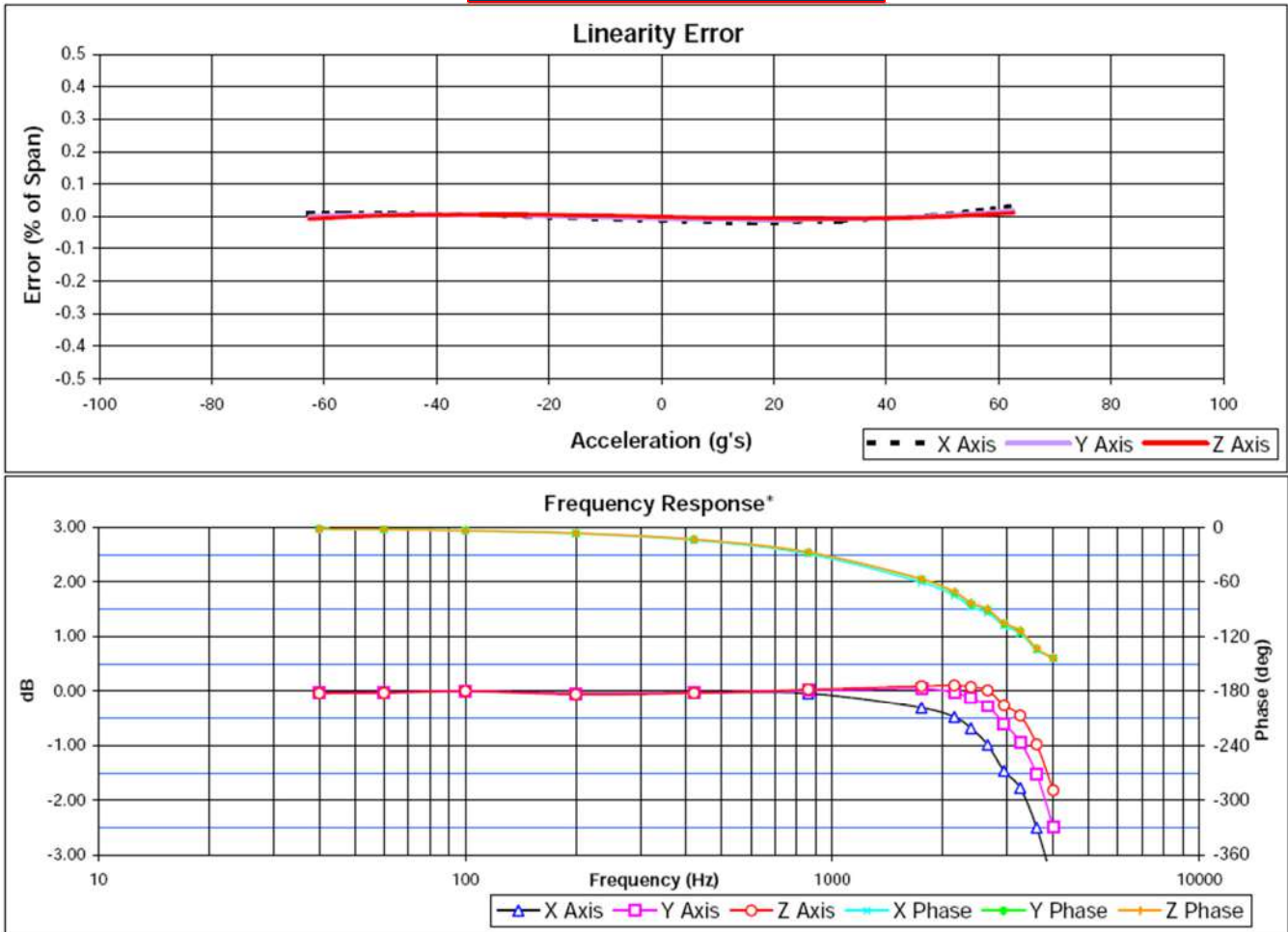

SPECIFICATIONS SUBJECT TO CHANGE WITHOUT NOTICE

**EXAMPLE 400G in 3-AXIS**

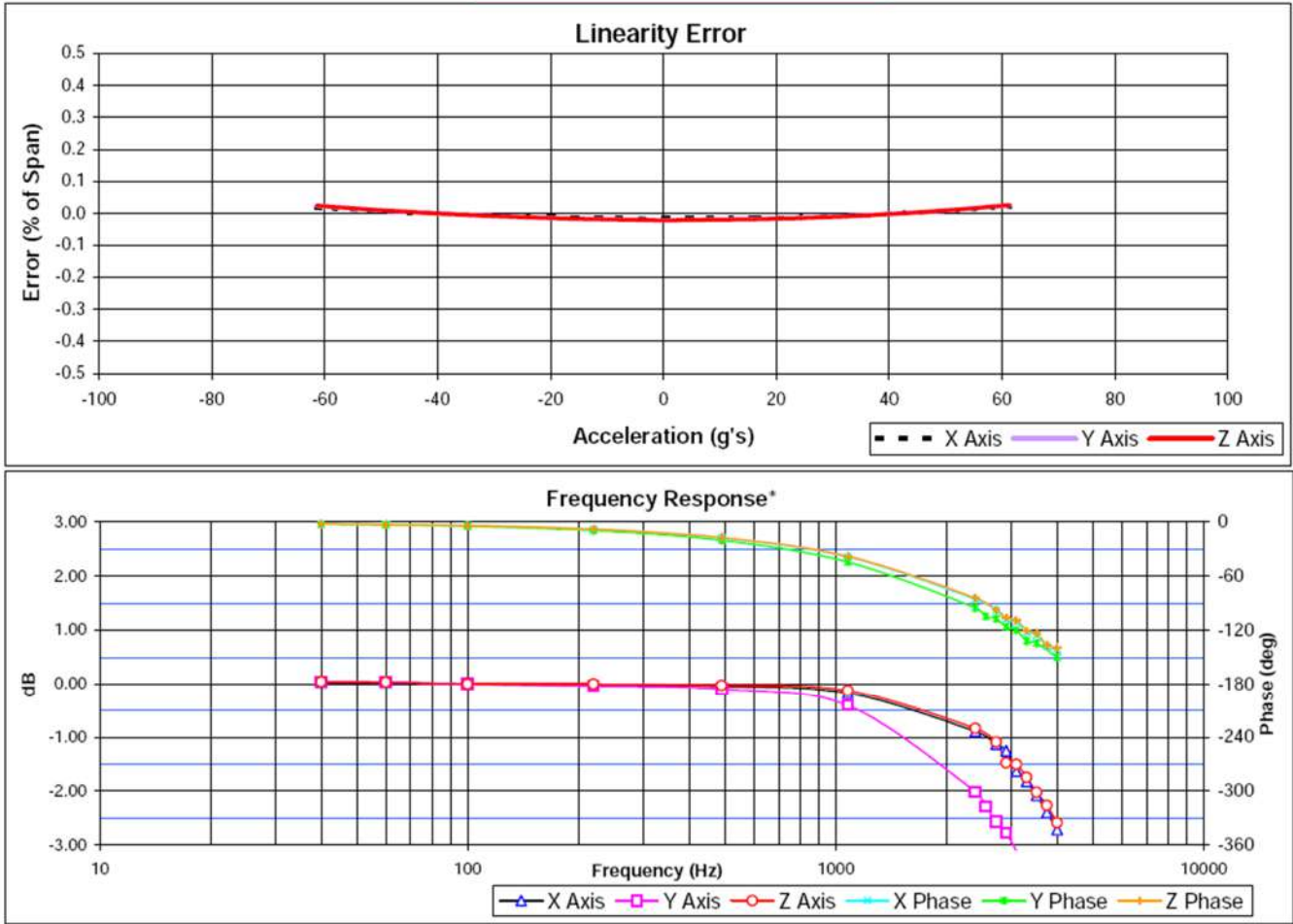

SPECIFICATIONS SUBJECT TO CHANGE WITHOUT NOTICE